

Optical Wavelength Laboratories

OPERATIONS GUIDE

WaveTrekker Optical Time Domain Reflectometer (OTDR)

Model Number: WTO-S15



Revision 1E

OWL-INC.COM

Optical Wavelength Laboratories (OWL)
N9623 West US Hwy 12
Whitewater, WI 53190
Phone: 262-473-0643
Internet: OWL-INC.COM

SECTION I: INTRODUCTION

TABLE OF CONTENTS

- SECTION I: INTRODUCTION**
- Before You Begin 1
- About This Manual 1
- Description 2
- Performance Expectations and Limitations 2
 - Reflective Events 2
 - Fault Location 2
 - Fiber Length Measurement 2
 - Backscatter Events 2
 - Backscatter Events 2
 - Attenuation Measurement 2
- Precautions 3
 - Optical Safety 3
 - Electrical Safety 3
 - Operational 3
 - Connector 3
 - Service 3
- Product Label 3
- Ports 4
- Buttons 4
- Display 5
- Indicator LEDs 5

- SECTION 2: OTDR TESTING**
- Power ON/OFF 6
- Setting Test Parameters 6
 - Index of Refraction 6
 - User Mode 6
 - Pulse Width 6
 - Samples 6
 - Dead Zone 6
 - Range 6
 - Selecting and Editing OTDR Test Parameters 6
- Starting an OTDR Trace 7
- Cursor Navigation 7

- SECTION 3: TRACE ANALYSIS**
- Overview 8
- Events 8
- Fiber Length Measurement/Link Loss 9
- Fiber Attenuation Measurement 9
- Reflectance Measurement 10

- SECTION 4: TRACE STORAGE**
- Stored Readings/Setup Menu 11
- Saving a Trace 11
- Loading a Previously Stored Trace 12

SECTION I: INTRODUCTION

TABLE OF CONTENTS

SECTION 5: OTDR SETUP AND HELP

Menus and Help Screens	13
Navigating the Menu System	13
Setup Menu	13
User Information Menu	14
Enter User Name	14
Enter Phone Number	14
Display Preferences	15
Mode	15
Brightness	15
Dimness	15
Speaker	15
Trace Clipping.	15
Power Options	16
Dim Time	16
Standby Time	16
Off Time	16
Utilities Menu	17
Set System Clock	17
Set APD Bias	17
Format Data Flash.	17
Trace Screen Help Text	18
Trace Setup.	18
Status Bar	18
Using Cursors.	18
Numeric Values	19
Function Buttons	19
Stored Traces	20
Text Entry	20
User Options Help Text	21
User Information	21
Display Preferences	21
Power Options	21
Utilities Menu	21
Utilities Menu Help Text	22
Set System Clock	22
Set APD Bias	22
Format Data Flash.	22

SECTION 6: OPERATION/MAINTENANCE

Cleaning the OTDR Port	23
----------------------------------	----

SECTION 7: APPENDICES

Specifications	24
Maintenance Information	24
Contact Information	24

SECTION 8: APPLICABLE DOCUMENTS

Manual Intended Usage	25
---------------------------------	----

SECTION I: INTRODUCTION

BEFORE YOU BEGIN

All personnel testing optical fibers should be adequately trained in the field of fiber optics before using any fiber optic test equipment. If the user is not completely familiar with testing fiber optics, they should seek competent training. Such training can be acquired from a variety of sources, such as local hands-on training classes.

This is especially true for Optical Time Domain Reflectometers (OTDRs). OTDRs are complicated technical devices, requiring a great amount of technical skill, knowledge, and expertise to operate. Proper setup and trace interpretation are paramount to a successful OTDR test, and the consequences of being inadequately trained could result in a significant amount of network down-time and repair costs.

In addition, OTDRs are delicate scientific instruments, and should be treated as such. Great care should be taken to ensure that all optical ports are kept clean and free from debris. The reasons for this are two-fold: 1) a clean OTDR produces accurate and precise results; and 2) if debris is allowed to build up in the OTDR test port, over time connector insertions will grind the debris into the OTDR port endface, resulting in scratches or “pits” that require extensive and costly repairs.

Valuable information about fiber optic testing can also be gathered from reading printed literature carefully or by thoroughly reading supplied operations manuals.

The main reason to use an OTDR is to locate faults in an optical fiber that exhibits unacceptable amounts of optical loss, or is no longer functioning properly. These faults are commonly called “events” and include anomalies such as breaks, shatters, connector endfaces, patch panels, and splices. By knowing the precise distance to an event, the technician can determine the nature of the event and quickly restore the network to its former working state.

There are two types of events detectable by an OTDR: Fresnel (reflective) and backscatter (non-reflective).

Fresnel events are caused by “glass-to-air” boundaries in the optical fiber, which causes a high amount of light to be reflected directly back toward the OTDR. Common Fresnel events include breaks, shatters, connector endfaces, patch panels, or even the end of the fiber. End-of-fiber detection can also be used to measure the end-to-end length of the fiber.

Backscatter events are caused by the intrinsic properties of the optical fiber. The make-up of the optical fiber scatters the light in all directions, including a small amount that gets scattered back towards the OTDR. Common backscatter events are splices, (either fusion or mechanical), macro-bends, and micro-bends. Backscatter can also be used to measure the attenuation (loss) on a certain section of an optical fiber.

ABOUT THIS MANUAL

Throughout this manual you will find various symbols that assist with understanding the procedures outlined in this manual. Below is a list of these symbols and a short description of their purpose:



Helpful tip



Cautionary information



Potentially dangerous condition or operation

SECTION I: INTRODUCTION

DESCRIPTION

Upholding OWL's commitment to high-quality, yet affordable, fiber optic test equipment, the WaveTrekker OTDR from OWL enables fiber optic professionals to quickly and easily troubleshoot and locate optical faults in singlemode fibers.

The WaveTrekker is truly a hand-held unit, being one of the smallest OTDRs on the market today – easily able to fit into a shirt pocket – yet having capabilities of other OTDRs costing thousands of dollars more.

Optical fiber traces are displayed on a high-resolution color LCD display which implements state-of-the-art display technology to allow the OTDR's high-resolution color LCD display to “flip” between portrait or landscape mode automatically simply by rotating the device 90°. By “flipping” from portrait to landscape, the user sees a wider viewing area, displaying more trace information on the high-resolution color LCD, and allowing for greater viewing detail.

Important OTDR trace parameters such as pulse width, index of refraction, and data point averaging are fully user-configurable, and are accessible through an intuitive menu system. Up to 1000 traces can be stored in the WaveTrekker's internal memory.

Powering the WaveTrekker is a re-chargeable Lithium-polymer battery that allows for up to 20 hours of normal usage.

The WaveTrekker is equally suited to testing singlemode fibers in many test environments, including LAN, MAN, WAN, FTTH, Telco, CATV, Manufacturing, and Laboratory.

PERFORMANCE EXPECTATIONS AND LIMITATIONS

REFLECTIVE EVENTS

Fault Location. The main function of the WaveTrekker OTDR is to detect the presence of highly reflective events, otherwise known as Fresnel events, such as breaks, shatters, patch panels, or the end of the fiber link. The distance to an event is shown as a spike on the OTDR trace, allowing the technician to quickly locate the problem and restore the network.

Fiber Length Measurement. The WaveTrekker can give the operator a general idea of the length of the optical fiber by placing the cursors at the first and last reflective events, although the last reflective event is not guaranteed to be the end of the fiber. For example, a severe enough break mid-span could prevent the OTDR from detecting other events beyond the break, or the OTDR trace could show echoes or ghosts of previous Fresnel events.

BACKSCATTER EVENTS

Backscatter Events. The WaveTrekker has some ability to locate and measure backscatter events. Tweaking pulse-width and averaging settings may enhance the WaveTrekker's ability to detect backscatter events. However, even with optimal settings, low loss backscatter events will become less detectable as the event gets farther away from the beginning of the fiber, especially on longer fibers.

Backscatter events are also more difficult to measure and interpret. Proper cursor placement is vital to the accurate measurement of backscatter events. Only individuals with OTDR training and expertise should attempt backscatter event measurement. Interpreting OTDR traces will be covered in more detail later in this manual.

Attenuation Measurement. Backscatter can be used to measure the attenuation (or loss) of certain sections of an optical fiber by placing the cursors at the beginning and end of the segment of fiber to be measured.

If available, however, a Power Meter / Light Source (PMLS) test kit or Optical Loss Test Set (OLTS) should always take precedence over an OTDR for end-to-end attenuation measurements.

SECTION I: INTRODUCTION

PRECAUTIONS

Eye Safety



NEVER look into the connector port of any fiber optic test or transmission equipment, patch cable, fiber link, or other installed fiber. Always assume that active laser equipment is attached to optical fibers, and is powered on.



Do not run a test on the OTDR unless it is connected to the fiber under test, or the dustcap is firmly in place.

Electrical Safety



Only use appropriate AC adapters for charging this device. Use of inappropriate power adapters could cause damage to the device, and could cause harm to the user from fire and electrical shock.

Operational



Keep connector ferrules and optical connector ports clean to prevent irreparable damage to the OTDR port. For best results, replace dust caps after each use.

Connector



For best results, do NOT insert APC (Angled Physical Contact) connectors into the OTDR port.

Service



There are no user-serviceable parts in this device. Unauthorized attempts to service this product will void the product warranty.

PRODUCT LABEL

On the back of each WaveTrekker OTDR is a label similar to the one shown here containing model number, serial number, power requirements, and special cautionary information.

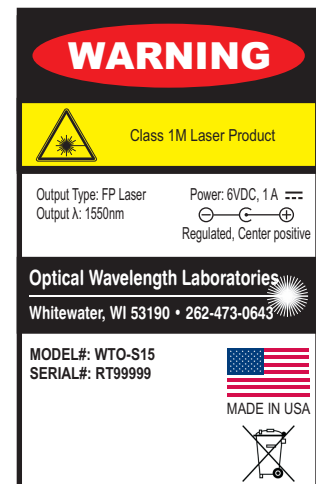

SECTION I: INTRODUCTION

PORTS

- 1 **Reset Button** – resets the OTDR in case of malfunction
- 2 **Battery Charger Port** – re-charges the Lithium Polymer battery when used with approved wall charger
- 3 **USB Download Port** – downloads data from the OTDR to the PC for software trace analysis and digital data storage
- 4 **OTDR Port** – connects the OTDR to the fiber under test

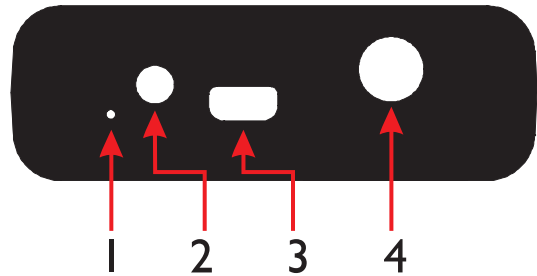

BUTTONS

- 5 **Menu Buttons** – activates the associated menu option
- 6 **Navigation Buttons** – moves cursors or menu options in the direction of the button, or are used to zoom in or out on cursor placement
- 7 **Power Button** – powers the OTDR on; press and hold to power off; also, while the OTDR is on, brief press will activate other functions
- 8 **Enter Button** – from the trace screen, this button changes the function options menu at the bottom of the screen. Also activates menu options while in the menu system



SECTION I: INTRODUCTION

DISPLAY

- 9 Fiber ID – name of the currently loaded fiber trace
- 10 OTDR Test Mode – shows which test mode the OTDR is in – AUTO, USER, or SEMI
- 11 Battery Life Indicator – displays the remaining battery life
- 12 Trace Viewing Area – displays the results of the OTDR trace, which users can zoom in on for more detailed trace analysis
- 13 Trace Information – displays the relative position and power levels at and between the red and green cursors
- 14 Function Options Menu – displays the on-screen menu options for trace control

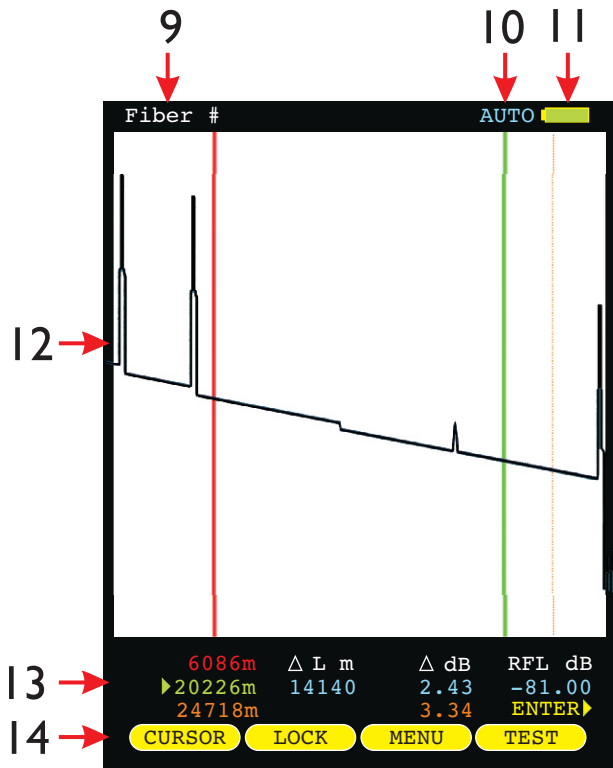

INDICATOR LEDs

- 15 **CHARGING STATUS** – will be lit when charging through a transformer or USB port
 - GREEN battery fully charged
 - ORANGE battery charging
 - RED problem with battery and/or charger; contact OWL for service
- 16 **STANDBY STATUS** – blinks when OTDR is in STANDBY; press any key to “wake up” the device

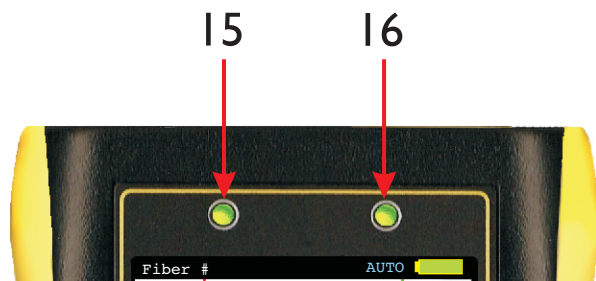

SECTION 2: OTDR TESTING

POWER ON/OFF

POWER ON

Press  to power on the OTDR.

When the OTDR has completed startup, the trace area will either be blank, as shown at right, or will show the previously viewed trace.

Continue below for more information about running a new OTDR trace.

POWER OFF

The OTDR may be powered off from any screen by holding .

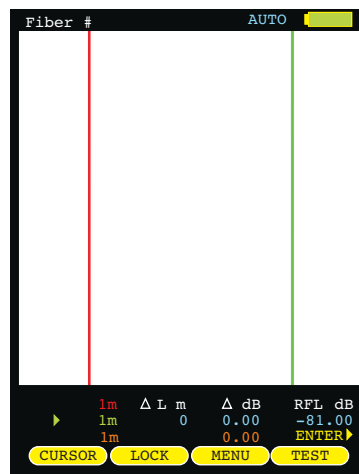

SETTING TEST PARAMETERS

Below is a descriptive list of key OTDR trace parameters.

INDEX OF REFRACTION – range of values: 1.4000 to 1.6000. To ensure the most accurate distance to events, Index of Refraction (IoR) should be set to the fiber manufacturer’s refractive index specification for the fiber under test. If unknown, set IoR to 1.4681 as this value falls within 99% of the IoR values for most optical fibers.

USER MODE – range of values: AUTO, USER, SEMI. AUTO mode attempts to determine the best set of parameters based upon the fiber under test. USER mode allows the user to set all parameters manually. SEMI mode uses manually set parameters, except range.

PULSE WIDTH – range of values: 5, 10, 20, 50, 100, 200, 500ns; 1, 10 μs. Pulse width offers a trade-off between the ability to measure longer cable distances (longer pulse width) versus the ability to see two events that are closely spaced (shorter pulse width). This is otherwise known as an OTDR’s event dead zone (i.e. the minimum distance between two events where they both can be measured).

SAMPLES – range of values: 256, 512, 1024, 2048, 4096. Increasing the number of samples allows the OTDR to have better display resolution (events are easier to see, especially near the noise level), but also increase the trace acquisition time.

DEAD ZONE – range of values: 0 to 1500. Allows the user to enter the length of a dead-zone box (a.k.a. pulse suppressor), if one is being used. If a value is entered for dead zone, the dead zone portion of the OTDR trace will be grayed out. The active portion of the trace will begin where the dead zone ends.

RANGE – range of values: 1, 2, 5, 10, 25, 50, MAX km. Allows the user to manually enter the total length of the trace. NOTE: for best results, this value should be set to the next highest value from the actual length of the fiber under test.

SELECTING AND EDITING OTDR TEST PARAMETERS

While at the trace screen, press  until the following menu options appear:



allows the user to change the index of refraction; setting will appear at the top of the trace screen.



opens the trace options menu, where the user can set USER MODE, PULSE WIDTH, SAMPLES, DEAD ZONE, and RANGE.

SECTION 2: OTDR TESTING

STARTING AN OTDR TRACE

Once the OTDR parameters have been set, an OTDR trace can be run.

TEST starts an OTDR trace based upon the current OTDR parameters

During the OTDR test (as shown at right):

- the TEST soft-key switches to ABORT (used to abort an OTDR trace)
- all other soft-keys are disabled
- a bar graph appears at the top of the screen showing the progress of the OTDR test

 starting a new trace will replace the old trace on the display with the new trace after a few seconds (depending upon the trace length).

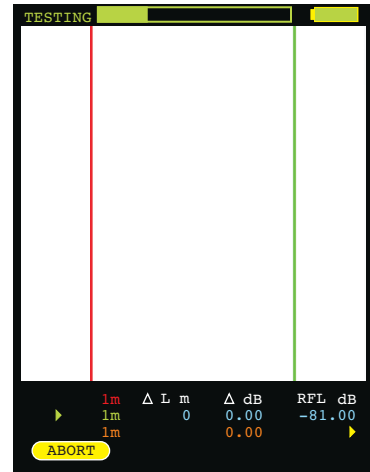



CURSOR NAVIGATION

Once the OTDR trace is complete, the OTDR trace will appear on the screen, and the OTDR information – distance and optical power – will be updated.

Trace information is color-coded. Red and green refer to the cursors. Blue text refers to the difference between the two cursors. Orange text refers to the perceived end of the fiber link.

CURSOR sets the active cursor – no cursor, red, green, or both red and green

LOCK locks the active cursor at its current location; unlocks a locked cursor

  **WHEN ONE OR MORE CURSORS ARE SELECTED:** moves the cursor(s) left or right; holding these buttons speeds up the cursor movement

WHEN NO CURSOR IS SELECTED: screen pans left and right

  **WHEN ONE OR MORE CURSORS ARE SELECTED:** zooms in or out on the active cursor(s)

WHEN NO CURSOR IS SELECTED: zooms in and out on the center of the screen

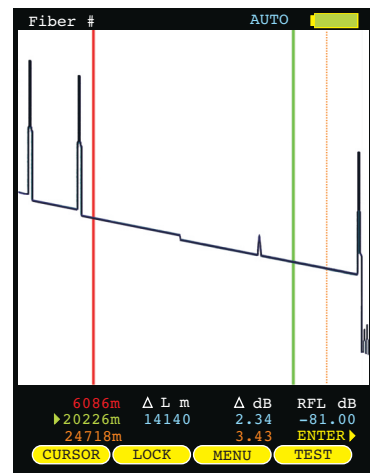

SECTION 3: TRACE ANALYSIS

OVERVIEW

This section will provide a basic overview about how to analyze an OTDR trace, and will cover the different types of information that can be gathered from an OTDR trace, including:

- event location;
- fiber length measurement;
- fiber attenuation (loss); and
- reflectance measurement.

 proper interpretation of OTDR test results requires a significant amount of technical skill, knowledge, and expertise. Proper trace interpretation is paramount to a successful OTDR test, and the consequences of interpreting a trace incorrectly could result in a significant amount of network down-time and repair costs.

EVENTS

The primary function of an OTDR is to locate events along the optical fiber. On an OTDR trace, events appear as deviations from an otherwise gently sloping line.

Below is a list of the different events shown in the example at right, including the type of event, and possible interpretations of the data:

- | | | |
|----------|-------------|-------------------------------------------------------------------------------------------------------------|
| 1 | Fresnel | end of dead-zone box (pulse suppressor) |
| 2 | Fresnel | patch panel using flat polish connectors |
| 3 | Backscatter | fusion splice or macro-bend |
| 4 | Fresnel | patch panel using APC (angled physical contact) connectors |
| 5 | Fresnel | end of fiber link; could also indicate a severe break where no other events can be detected after the break |

 If the slope of the trace appears to “dip” to a lower level after the event (events 1, 2, and 3), this could mean one of two things: 1) if the slope of the line changes, the refractive index of the fiber preceding the event is different from the refractive index of the fiber following the event, or 2) if the slope stays the same, then the event is simply a loss-inducing event.

 Tall spikes usually indicate flat polish connections or other highly reflective events (breaks, shatters, end of fiber, etc.), while short spikes usually indicate angled polish connections.

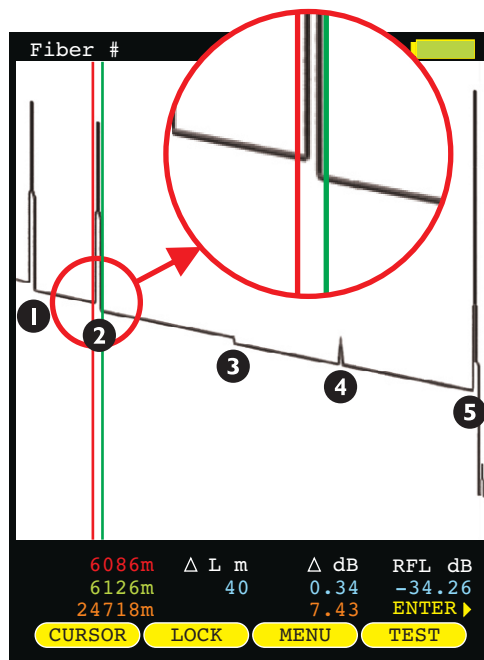

CURSOR PLACEMENT

Proper cursor placement is critical in determining the exact distance to an event, as well as the relative effect the event has on optical power traveling through the event.

The **red** cursor should be placed right before the slope of the line begins to spike.

The **green** cursor should be placed after the event, at a point where the slope of the line returns to the normal backscatter level.

The trace information (located below the trace) will show the distance and relative power (in dB) at the point where each cursor is placed.

SECTION 3: TRACE ANALYSIS

FIBER LENGTH MEASUREMENT/LINK LOSS

By placing the cursors at the beginning and ending points of the fiber trace, the distance between the cursors will show a close approximation of the total length of the optical fiber link, as well as a close approximation of the total fiber link loss.

CURSOR PLACEMENT

Proper cursor placement is necessary to determine the end to end length and link loss of an optical fiber link. Refer to the diagram at right when placing cursors for fiber length measurement.

The **red** cursor should be placed directly before the first reflective event, before the slope of the line begins to spike.

The **green** cursor should be placed directly before the last event, before the slope of the line begins to spike.

The trace information (located below the trace) will show the distance and relative power (in dB) at the point where each cursor is placed, as well as the total link distance and end-to-end link loss.

In this example, the total link length is **24718 meters**, and the end-to-end link loss is **7.43 dB**.

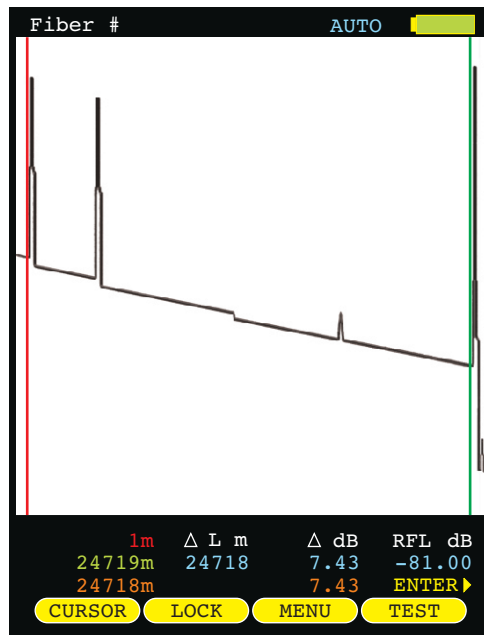

FIBER ATTENUATION MEASUREMENT

The fiber attenuation, or loss, for a certain section of an optical fiber link can be determined by placing the cursors at the beginning and end points of the segment of fiber under test.

CURSOR PLACEMENT

Proper cursor placement is necessary to determine the attenuation of a certain segment of fiber.

The **red** cursor should be placed at the beginning of the section of fiber under test.

The **green** cursor should be placed at the end of the section of fiber under test.

The trace information (located below the trace) will show the distance and relative power (in dB) at the point where each cursor is placed, as well as the loss and distance of the section of fiber being analyzed.

In this example, the section of fiber being analyzed has **1.76 dB** of loss, and is **7040 meters**.

Using this information, dB per kilometer can also be calculated, which can be compared to the fiber manufacturer attenuation specification. To determine dB/km:

$$1.76 \text{ dB} / 7.040 \text{ km} = 0.25 \text{ dB/km}$$



In the example shown here, the attenuation measurement also includes the loss through the connector located near the red cursor.

SECTION 3: TRACE ANALYSIS

REFLECTANCE MEASUREMENT

The reflectance of a specific event can be determined by placing the cursors on either side of an event. The OTDR will show the reflectance in dB of the highest reflective event between the cursors.

CURSOR PLACEMENT

Proper cursor placement is important when determining the reflectance of a reflective event.

The **red** cursor should be placed on the backscatter line directly before the event, on the sloping line right before the spike.

The **green** cursor should be placed on the backscatter line somewhere after the event.

- ✓ Make sure that only one reflective event is included between the cursors.

The trace information (located below the trace) will show the reflectance (in dB) of the highest reflective event between the cursors.

In this example, the reflective event being measured has a reflectance of **-34.26 dB**.

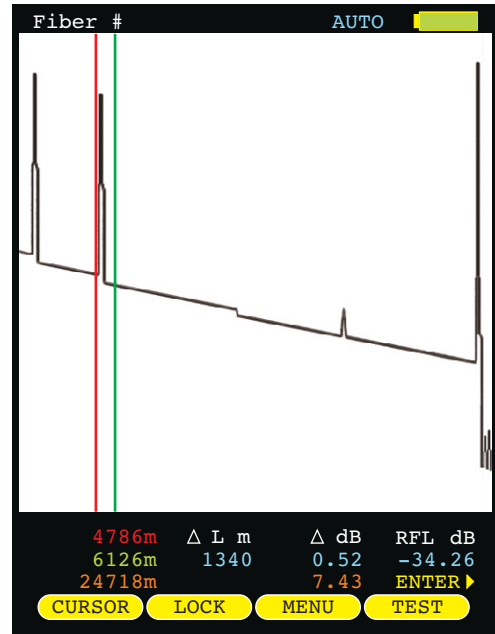

SECTION 4: TRACE STORAGE

STORED READINGS / SETUP MENU



sets the Function Options Menu to allow access to Data Storage and Setup Menu options.

Each of these menu options will be discussed in detail later in this manual.



SAVING A TRACE



LOADING A PREVIOUSLY STORED TRACE



NAMING A TRACE



SETUP MENU

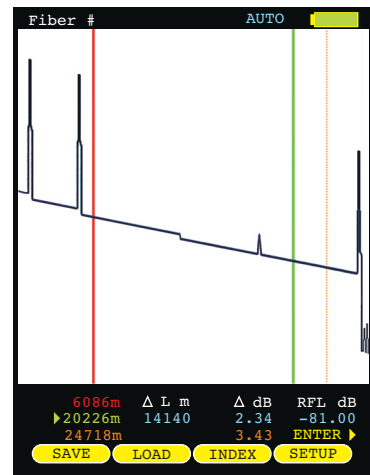

SAVING A TRACE

Traces may be stored in permanent memory for later viewing or download to hard disk for data file retrieval.

Press **SAVE** on the trace screen to enter the fiber name and save the currently displayed trace to memory.

Use the arrow keys to highlight the appropriate character on the grid.



BACKSPACE



TOGGLE BETWEEN UPPER AND LOWER CASE ALPHABET



FORWARD SPACE



SELECT THE HIGHLIGHTED CHARACTER



FINISHED ENTERING NAME

SECTION 4: TRACE STORAGE

LOADING A PREVIOUSLY STORED TRACE

Previously stored traces can be loaded from memory for later on-screen analysis.

From the STORED READINGS menu, press  to access the STORED TRACES menu.

From the STORED TRACES menu:



moves the cursor up and down in the list of stored traces



loads the currently selected fiber trace into the trace screen



returns to the trace screen







deletes the currently selected fiber trace



displays the next page of fiber traces if there are more traces than will fit on the screen

STORED TRACES		
Trace Name	Date	Time
SM-BB-F1-F2:1	10/05/09	04:16PM
SM-BB-F1-F2:2	10/05/09	04:17PM
SM-BB-F1-F2:3	10/05/09	04:19PM
SM-BB-F1-F2:4	10/05/09	04:21PM
SM-BB-F1-F2:5	10/05/09	04:24PM
SM-BB-F1-F2:6	10/05/09	04:27PM

n=1.4681 L=33600 P= 10us

Information at the bottom of the STORED TRACES screen shows the index of refraction, fiber length, and pulse width settings used for the highlighted trace.

SECTION 5: OTDR SETUP AND HELP

MENUS AND HELP SCREENS

To access the SETUP MENU, either press  or .

NAVIGATING THE MENU SYSTEM

The arrow keys are used to navigate throughout the various menus and help screens in the OTDR. Green selection arrows highlight different menu options.

  moves the selection arrows to the next or previous menu option

 jumps to the highlighted menu option

 returns to the previous menu

 exits the menu system

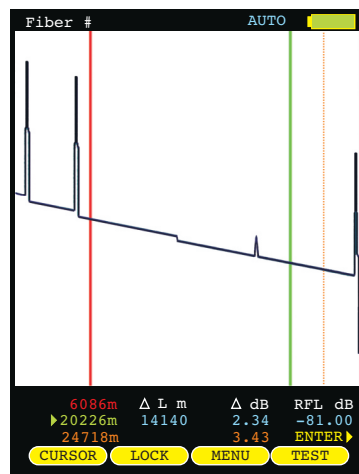

SETUP MENU

The SETUP MENU is the main entry point into the OTDR menu system. Shown below is a tree of menu options.

Each option will be explained in detail on the following pages.

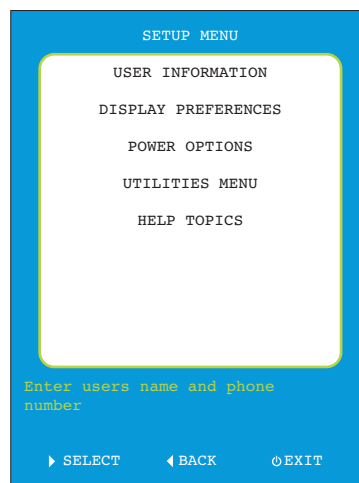

USER INFORMATION

USER MENU

USER NAME >> Enter user name

USER PHONE >> Enter phone number

DISPLAY PREFERENCES >> Display options

POWER OPTIONS >> Power saving options

UTILITIES MENU

SET SYSTEM CLOCK >> Set time & date

SET APD BIAS >> Set APD bias voltage

FORMAT DATA FLASH >> Format data flash

HELP TOPICS

USER OPTIONS

USER INFORMATION >> User info help

DISPLAY PREFERENCES >> Display options help

POWER OPTIONS >> Power saving options help

UTILITIES >> Utilities help

TRACE SCREEN

TRACE SETUP >> Proper trace setup

STATUS BAR >> Status bar information

USING CURSORS >> Using trace cursors

NUMERIC VALUES >> Interpreting trace info

FUNCTION BUTTONS >> Function buttons

STORED TRACES >> Working with stored traces

TEXT ENTRY >> Entering data into text entry fields

SECTION 5: OTDR SETUP AND HELP

USER INFORMATION MENU

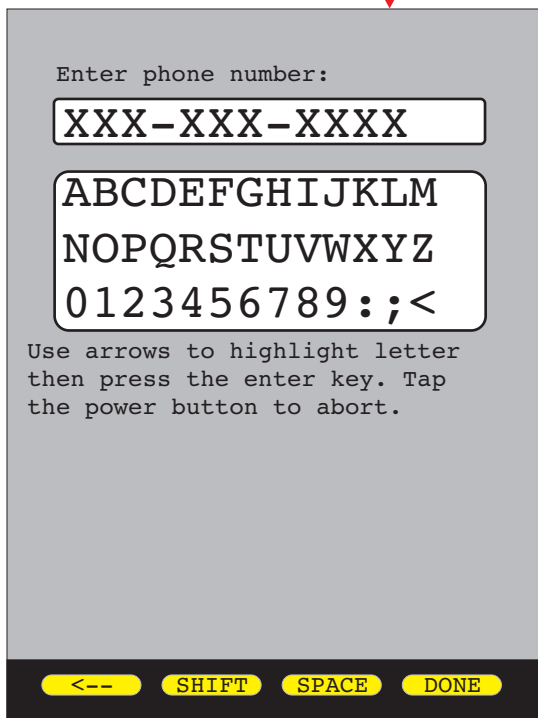
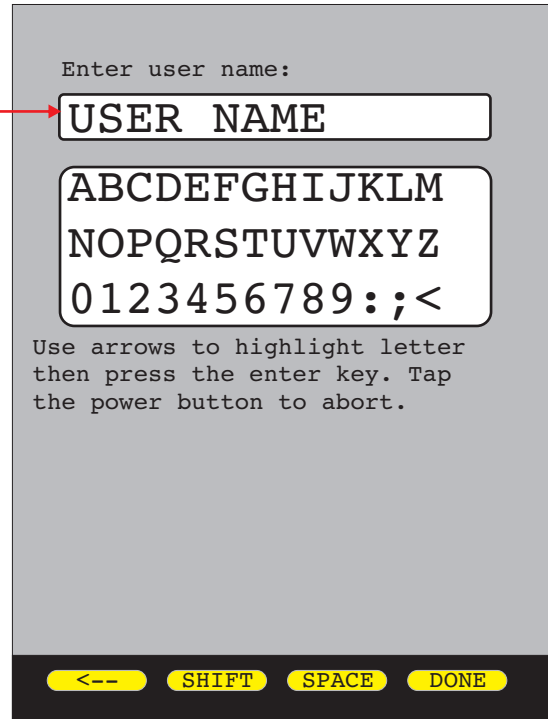
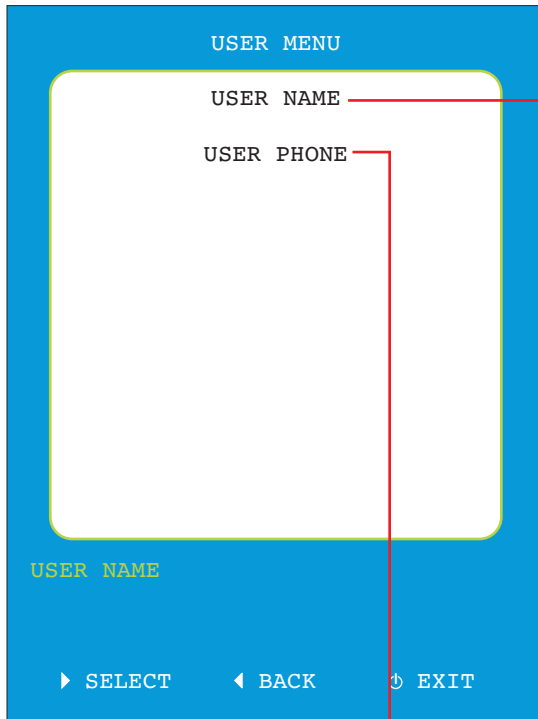

Enter user name:

Enter the name of the person or company who owns the OTDR. This information will appear on test reports.

Up to 16 characters are allowed in the user name entry field.

See the on-screen instructions for help with text entry.

Enter phone number:

Enter the phone number of the person or company who owns the OTDR. This information will appear on test reports.

Up to 13 characters are allowed in the phone number entry field.

See the on-screen instructions for help with text entry.

SECTION 5: OTDR SETUP AND HELP

DISPLAY PREFERENCES

DISPLAY OPTIONS

MODE : **FLIP**

DIMNESS : **063**

BRIGHTNESS : **255**

SPEAKER : **ON**

TRACE CLIPPING : **ON**

SAVE **QUIT** **HELP**

MODE:
Sets the orientation of the LCD display. Three modes are available:

FLIP	LCD automatically alternates between portrait and landscape modes based upon the physical orientation of the OTDR
PORTRAIT	display is always in portrait mode
LANDSCAPE	display is always in landscape mode

DIMNESS:
Sets the level of the LCD backlight during power saving mode. Range of values are 25 (dimmest) to 125 (brightest).
NOTE: higher values require more battery power

BRIGHTNESS:
Sets the level of the LCD backlight during normal operation. Range of values are 150 (dimmest) to 255 (brightest).
NOTE: higher values require more battery power

SPEAKER:
Toggles the internal speaker either ON or OFF.

TRACE CLIPPING:
Toggles trace clipping mode either ON or OFF.
On a normal OTDR trace, as the sloping line of the trace approaches the noise floor of the OTDR, the trace starts becoming less smooth, making events harder to see near the end of the trace.
Trace clipping is a method that “clips” the top of the most reflective peaks, in order to draw the sloping line away from the noise floor. This effectively smooths out the trace, allowing smaller events to be more easily detectable.
While trace clipping is ON, reflectance measurements of clipped events are not affected.

SECTION 5: OTDR SETUP AND HELP

POWER OPTIONS

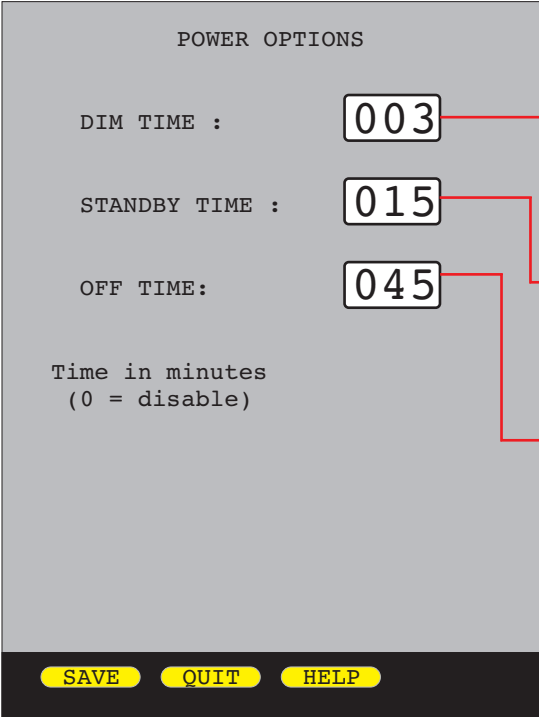

DIM TIME:

Sets the time (in minutes) before the display will enter DIM mode. Range of values is 1 to 250.

STANDBY TIME:

Sets the time (in minutes) before the OTDR will enter STANDBY mode. Range of values is 2 to 250.

OFF TIME:

Sets the time (in minutes) before the OTDR will power off. Range of values is 3 to 250.

SECTION 5: OTDR SETUP AND HELP

UTILITIES MENU

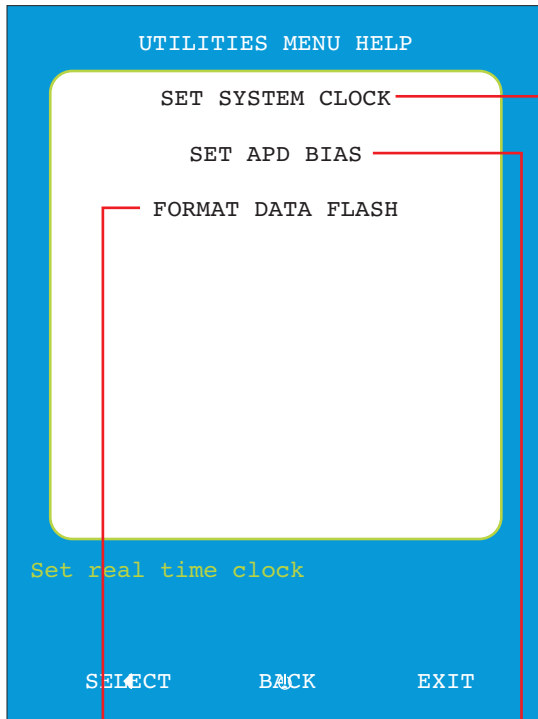

Set System Clock

Sets the current time and date in the OTDR.

Trace time and date are a part of the stored trace information and appear on test reports.

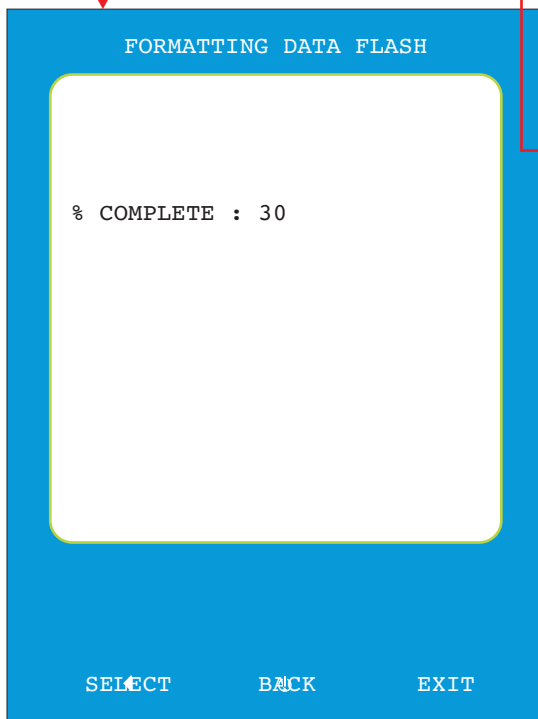
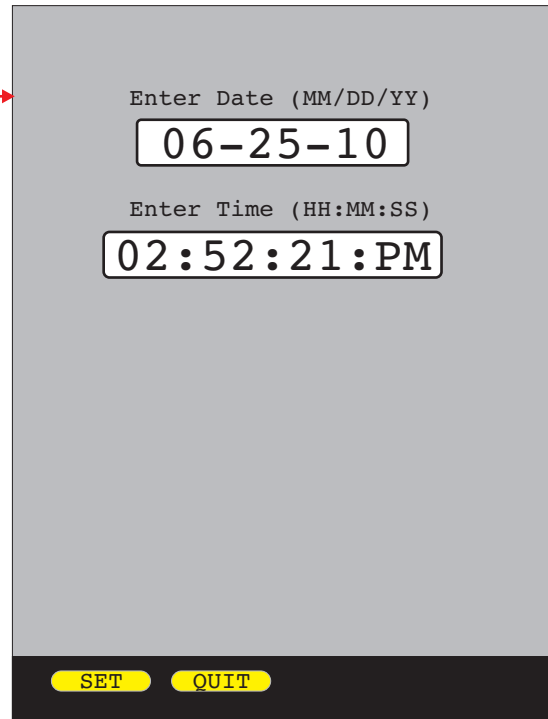

Set APD Bias

Sets the high voltage bias of the avalanche photodiode.

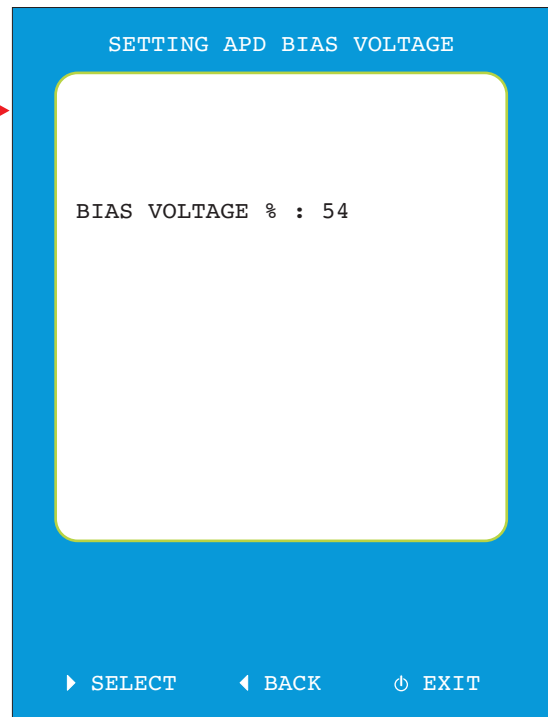

Format Data Flash

Initializes the internal trace storage memory. This option will erase all stored traces, and should only be used in cases where the file system has become corrupted.

SECTION 5: OTDR SETUP AND HELP

TRACE SCREEN HELP TEXT

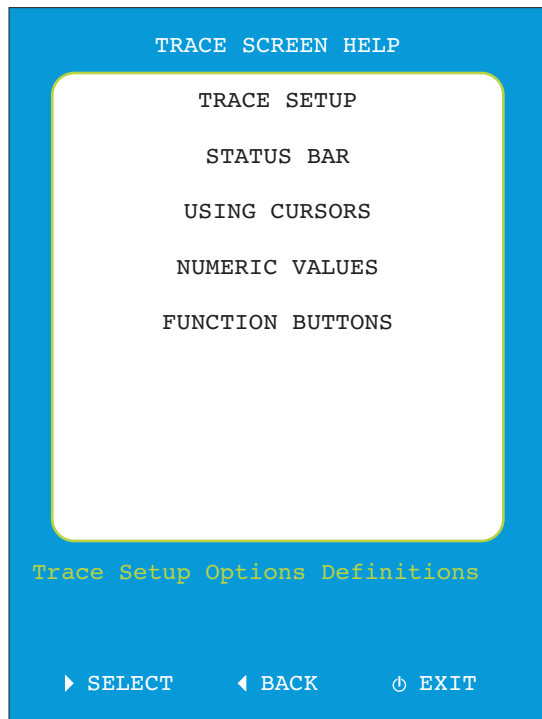

TRACE SETUP

PULSE WIDTH

Range of values: 5, 10, 20, 50, 100, 200, 500nm; 1, 10 μ s

Pulse width offers a trade-off between the ability to measure longer cable distances (longer pulse width) versus the ability to see two events that are closely spaced (shorter pulse width). This is otherwise known as the OTDRs event dead zone (i.e. the minimum distance between two events where they can both be measured separately).

SAMPLES

Range of values: 256,512,1024,2048,4096

Increasing the number of samples allows the OTDR to have better display resolution (events are easier to see, especially near the noise floor), but also increases the trace acquisition time.

RANGE

Range of values: 1,2,5,10,20,50,MAX km

The range should be set to the next longest setting than the fiber under test (including dead-zone boxes). Setting the value too short cuts off the end of the trace; setting the value too long increases trace acquisition time and increases the likelihood of seeing echoes or "ghosts".

STATUS BAR

The status bar is located at the top of the display, above the trace area. Battery status will always be shown at the right, and the test mode will appear next to the battery status. On the left side of the status bar, when:

- viewing a trace, the fiber number is shown;
- setting index of refraction, the index number is shown;
- running a trace, the trace progress bar is shown;
- saving a trace, the saving progress indicator is shown.

USING CURSORS

On the trace area, there are 2 positional cursors, red and green. Below the trace area are the corresponding distances, measured from the beginning of the fiber.

Cursors are positioned at certain points on the trace to determine the distance to an event, or the distance between two points on the trace.

- Use the CURSOR soft-key to select the cursor(s) you want to move.
- Once selected, use the left and right arrows to re-position the cursors.
- Use the LOCK soft-key to lock the cursor at their present position.
- Use the up arrow to zoom in on the selected cursor(s), and use the down arrow to zoom out.

SECTION 5: OTDR SETUP AND HELP

TRACE SCREEN HELP TEXT

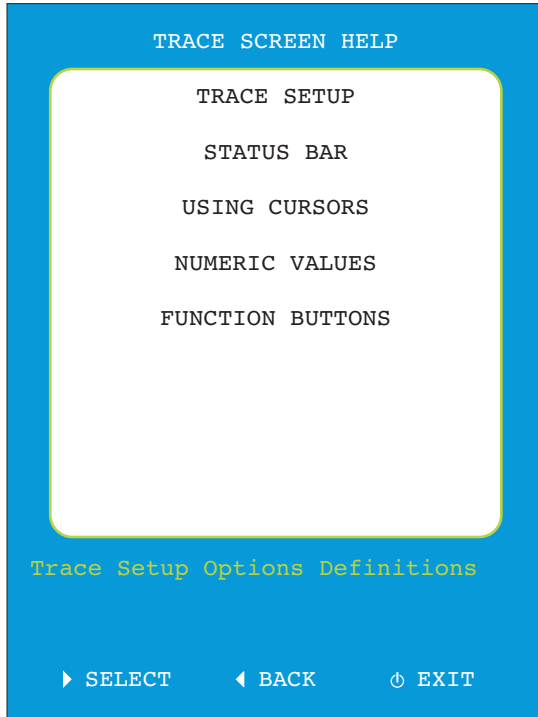

NUMERIC VALUES

Below the trace area are four columns (numbered 1-4 from left to right).

In column 1, red is the distance to the red cursor, green is the distance to the green cursor, and orange is the distance to the perceived end of the fiber.

Column 2 shows the distance between the red and green cursors.

Column 3 shows the power difference in dB between the two cursors, and the dB value at the perceived end of the fiber.

Column 4 shows the reflectance value of an event (see manual for more information about cursor placement for reflectance).

FUNCTION BUTTONS

The 4 function buttons below the LCD correspond to the soft-keys directly above each function button. The series of 4 soft-keys is called a function options menu.

The button at the lower right of the keypad is used to toggle between different function options menus.

SECTION 5: OTDR SETUP AND HELP

TRACE SCREEN HELP TEXT

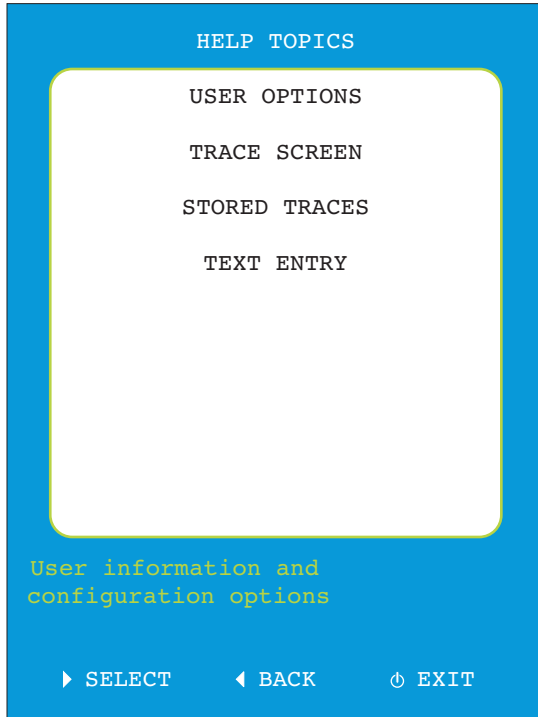

STORED TRACES

Allows the user to load a prior stored trace into memory.

UP/DOWNARROW KEYS: moves trace selection cursor up or down

LOAD: loads currently selected trace into memory and returns the user to the trace screen

ABORT: return to the trace screen without loading the selected trace

DELETE: deletes the currently selected trace

PAGE: scrolls through additional pages of stored traces, if present

At the bottom of the STORED TRACES screen is setup information for the currently selected trace:

n Index of refraction

L trace length setting

P pulse width

TEXT ENTRY

Text is entered using a virtual keypad. Use the arrow keys to select the next desired character and press the enter key to add it.

The F1 key will backspace one character.

The SHIFT function key will switch between upper and lower case keypads.

Press the DONE function key when finished.

SECTION 5: OTDR SETUP AND HELP

USER OPTIONS HELP TEXT

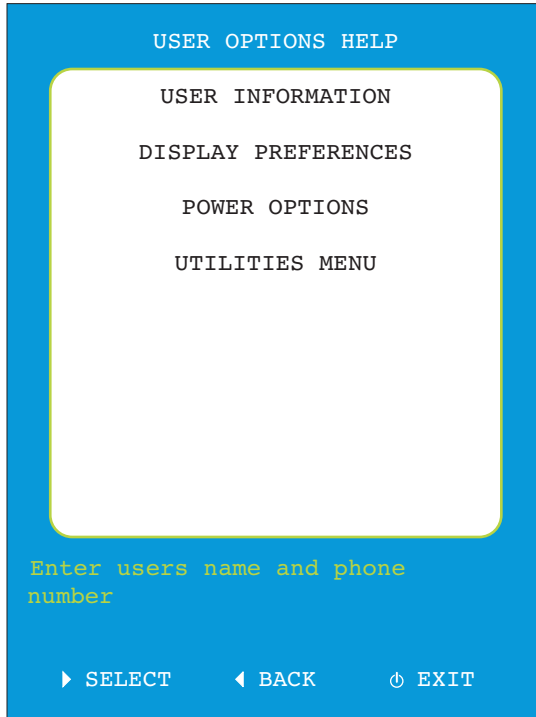

USER INFORMATION

Allows the user to enter a name and phone number.

Text is entered using a virtual keypad. Use the arrow keys to select the next desired character and press the enter key to add it.

The F1 key will backspace one character.

The SHIFT function key will switch between upper and lower case keypads.

Press the DONE function key when finished.

DISPLAY PREFERENCES

Allows the user to configure options for the LCD display, such as view mode, bright levels, dim levels, and speaker options.

UP/DOWN ARROW KEYS: moves display option cursor up or down

LEFT/RIGHT ARROW KEYS: changes the value of the currently selected display option

SAVE: saves the currently displayed options and returns the user to the setup menu

QUIT: returns to the setup menu without saving the display options

POWER OPTIONS

Allows the user to configure power saving options, such as dim time, standby time, and off time.

UP/DOWN ARROW KEYS: moves power option cursor up or down

LEFT/RIGHT ARROW KEYS: changes the value of the currently selected power option

SAVE: saves the currently displayed power options and returns the user to the setup menu

QUIT: returns to the setup menu without saving the power options

UTILITIES MENU

Jumps to the UTILITIES MENU HELP menu.

SECTION 5: OTDR SETUP AND HELP

UTILITIES MENU HELP TEXT

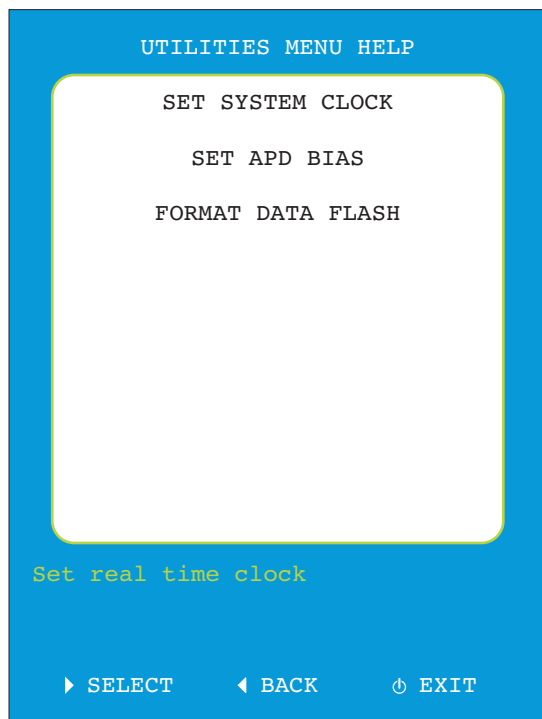

SET SYSTEM CLOCK

Sets the real time clock in the device

UP/DOWN ARROW KEYS: changes the value of the currently selected parameter

LEFT/RIGHT ARROW KEYS: moves the selection box to the left or right

SET: saves the currently displayed time and date and returns the user to the utilities menu

QUIT: returns to the utilities menu without setting the time and date

SET APD BIAS

Sets the high voltage bias on the avalanche photo diode

FORMAT DATA FLASH

This option initializes the internal trace storage memory. It will erase any stored traces that are in memory. This option is only necessary if the file system should become corrupt.

SECTION 6: OPERATION/MAINTENANCE

CLEANING THE OTDR PORT

This cleaning procedure applies to the OTDR port on the WaveTrekker OTDR.

Required Accessories:

- › Isopropyl alcohol (91% or better)
- › In-adapter fiber optic cleaning accessories, such as 2.5mm cleaning swabs or 2.5mm HUXCleaner™
- › In-adapter fiber optic inspection scope (LCD-based, 200x magnification or greater recommended)
- › Compressed Air (optional)

Below are procedures for “wet” cleaning and “dry” cleaning. For best results, a combination of these cleaning methods is recommended.



IMPORTANT SAFETY NOTE: WHEN INSPECTING AN OPTICAL PORT, NEVER LOOK DIRECTLY OR INDIRECTLY INTO THE PORT WITHOUT SUFFICIENT EYE PROTECTION. THE OPTICAL PORT MAY BE ENERGIZED WITH POWERFUL INVISIBLE RADIATION THAT IS HARMFUL TO THE HUMAN EYE.

INVISIBLE LIGHT IS ESPECIALLY DANGEROUS SINCE THE EYE IS NOT AWARE OF EXPOSURE TO HARMFUL INVISIBLE ENERGY, AND BECOMES INCREASINGLY DANGEROUS WITH PROLONGED EXPOSURE.

TO AVOID ACCIDENTAL EXPOSURE TO OPTICAL ENERGY, IT IS HIGHLY RECOMMENDED TO POWER OFF EQUIPMENT BEFORE INSPECTING OPTICAL PORTS.

IT IS ALSO HIGHLY RECOMMENDED TO USE AN LCD-BASED FIBER INSPECTION SCOPE, WHICH CAN INSPECT OPTICAL PORTS AND FIBER ENDFACES WITHOUT EXPOSING THE EYE TO HARMFUL OPTICAL RADIATION.

“WET” CLEAN PROCEDURE

- 1 Wet the tip of a 2.5mm cleaning swab with isopropyl alcohol.
- 2 Carefully insert the wet tip of the swab into the optical port.
- 3 Clean out the optical port according to the directions provided with the swabs.
- 4 Blow dry the optical port with the compressed air. If compressed air is not available, allow 2 minutes for the alcohol to evaporate.
- 5 Inspect the optical port with the in-adapter fiber optic inspection scope to ensure the port is clear of obstructions.

“DRY” CLEAN PROCEDURE

- 1 Carefully insert a dry 2.5mm cleaning swab or a 2.5mm HUXCleaner™ into the optical port.
 - 2 Clean out the optical port according to the directions that came with the cleaning accessories.
 - 3 Inspect the optical port with the in-adapter fiber optic inspection scope to ensure the port is clear of obstructions.
- If the port is still dirty, another round of cleaning will be necessary. You may also want to use a combination of “wet” and “dry” cleaning to achieve best results.

If the port is still dirty, another round of cleaning will be necessary. You may also want to use a combination of “wet” and “dry” cleaning to achieve best results.

SECTION 7: APPENDICES

SPECIFICATIONS

Output Wavelength	1550nm
Dynamic range	21 dB
Event dead zone	1 m typical / 2 m maximum
Attenuation dead zone	5m typical (8m max.)
Number of data points	~1 per meter
Resolution	1 m (over full range)
Pulse width	5, 10, 20, 50, 100, 200, 500ns; 1, 10µs
Distance range	up to 65 km
Index of refraction	1.4000 to 1.6000
Distance accuracy	1 m (over full range)
Number of traces	up to 1000
Display Type	High-resolution Color LCD
Battery Type	Lithium Polymer
Battery Life	up to 20 hours (normal usage)
Size	2.87"W x 4.42"H x 1.25"D
Weight	< 2 pounds

MAINTENANCE INFORMATION

Repair. Repair of this unit by unauthorized personnel is prohibited, and will void any warranty associated with the unit.

Battery Replacement. The WaveTrekker contains an internal Lithium Polymer battery. If the battery requires service, the device must be sent in to OWL. Unauthorized attempts to service the battery will void the product warranty.

Cleaning. For accurate readings, the optical connector port on the WaveTrekker and the connector on the patch cable should be cleaned prior to attaching them to each other. Minimize dust and dirt buildup by replacing the dust caps after each use.

Warranty. The WaveTrekker comes standard with a two-year factory warranty, which covers manufacturer defect and workmanship only.

CONTACT INFORMATION

Address:

Optical Wavelength Laboratories, Inc.
N9623 US Hwy 12
Whitewater, WI 53190

Phone:

262-473-0643

Internet:

OWL-INC.COM

SECTION 8: APPLICABLE DOCUMENTS

THIS MANUAL IS INTENDED FOR USE WITH:

FIRMWARE VERSION(S) XX.XX through XX.XX

SOFTWARE VERSION(S) XX.XX through XX.XX

VIDEO FILENAME(S) XXXXXXXX.WMV