

Optical Wavelength Laboratories

OPERATIONS GUIDE

OWLTrek II Optical Time Domain Reflectometer (OTDR)

Singlemode: WTO2-S15 / WTO2-S13 / WTO2-S35
Multimode: WTO2-M85 / WTO2-M13 / WTO2-M83



Revision 2A

OWL-INC.COM

Optical Wavelength Laboratories (OWL)
N9623 West US Hwy 12
Whitewater, WI 53190
Phone: 262-473-0643
Internet: OWL-INC.COM



WARNING!!!

HANDLE WITH EXTREME CARE!

This device contains expensive, extremely fragile optical fibers, lasers, and photodiodes.

This device is **highly susceptible** to **damage** from **impact** – avoid dropping this device.

DO NOT OPEN THIS UNIT!

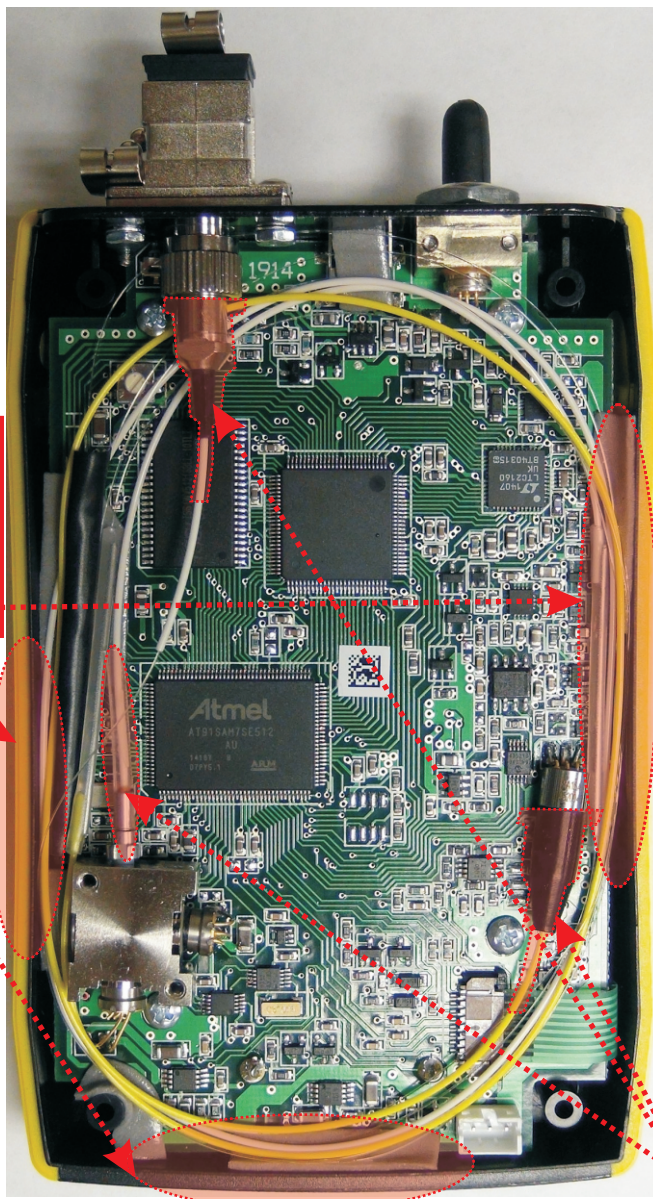

CRITICAL DAMAGE POINT
Fiber crush point near enclosure's edge.

NOTE: This is an issue for ALL SIDES of the enclosure when re-sealing the unit

CRITICAL DAMAGE POINT
Fiber coupling to laser and photodiode

SECTION I: INTRODUCTION

TABLE OF CONTENTS

SECTION I: INTRODUCTION

Before You Begin	1
About This Manual	1
Description	2
Performance Expectations and Limitations	2
Reflective Events	2
Fault Location	2
Fiber Length Measurement	2
Backscatter Events	2
Backscatter Events	2
Attenuation Measurement	2
Precautions	3
Eye Safety	3
Electrical Safety	3
Operational	3
Connector	3
Service	3
Product Label	3
Ports	4
Buttons	4
Display	5
Indicator LEDs	5

SECTION 2: OTDR TESTING

Power ON/OFF	7
Key OTDR Trace Parameters	7
Wavelength	7
Index of Refraction	7
Capture Mode	7
Pulse Width	7
Number of Samples	7
Dead Zone Length (m)	7
Range	7
Step	7
Setting Test Parameters	8
Set Wavelength	8
Set Index of Refraction	8
Setting Trace Options	9
Capture Mode	9
Pulse Width	9
Number of Samples	9
Dead Zone Length (m)	9
Range	9
Step	9
Starting an OTDR Trace	10
Cursor Navigation	10

SECTION 3: TRACE ANALYSIS

Overview	11
Events	11
Fiber Length Measurement/Link Loss	12
Fiber Attenuation Measurement	12
Reflectance Measurement	13
Trace Events Menu	13
Detector Saturation	14

SECTION I: INTRODUCTION

TABLE OF CONTENTS

SECTION 4: TRACE STORAGE	
Stored Readings/Setup Menu	15
Saving a Trace	15
Loading a Previously Stored Trace	16
SECTION 5: OTDR SETUP	
Menus	17
Navigating the Menu System	17
Setup Menu	17
Help Topics	17
Operational Menu	18
Set Backscatter Coefficient.	18
Trace Options	18
Set Length Units.	19
System Information	19
User Information Menu	20
Enter User Name	20
Enter Phone Number	20
Display Preferences	21
Mode	21
Dimness	21
Brightness	21
Speaker	21
Trace Clipping.	21
Power Options	22
Dim Time	22
Standby Time	22
Off Time	22
Utilities Menu	23
Set System Clock	23
Set APD Bias	23
Format Data Flash.	23
Manufacturer Setup	24
Factory Reset	24
SECTION 6: OPERATION/MAINTENANCE	
Visual Fault Locator (VFL) Operation	25
Fiber ID Tone Operation	26
Live Mode Operation	27
Cleaning the OTDR Port	28
SECTION 7: OWLVIEW FOR OTDR SOFTWARE	
Overview	29
Installing OWLView Software.	29
Installing from USB Flash Drive.	29
Installing from Website.	29
Launching the Software	30
Quick-Launch Panel	30
Operating the Software	30
Downloading Traces from the OTDR	30
Opening a Stored Trace	31
Saving Traces.	31
Printing Traces	31
Printing Multiple Traces	31
Closing Traces	32
Working with SOR Files	32
Exporting SOR Files	32
Batch Export SOR Files	32
Import SOR files.	32
Working with Traces	33
Button Controls	33
Thumbnail View	33

SECTION I: INTRODUCTION

TABLE OF CONTENTS

- Trace Details 33
- Trace Screen 34
- Event Table 34
- Miscellaneous Info 34
- Status Bar 34
- Rectangle Zoom 35
- Zoom In / Out 36
- Show / Hide Cursors 36
- Event Analysis / Proper Cursor Placement 36
- Tools Menu 36
 - Update Firmware 36
 - Change Length Units 36
 - Invert Y Axis 36
- Help Menu 36

SECTION 8: APPENDICES

- Specifications 37
- Maintenance Information 37
 - Repair 37
 - Battery Replacement 37
 - Cleaning 37
 - Warranty 37
- Contact Information 37

SECTION I: INTRODUCTION

BEFORE YOU BEGIN

All personnel testing optical fibers should be adequately trained in the field of fiber optics before using any fiber optic test equipment. If the user is not completely familiar with testing fiber optics, they should seek competent training. Such training can be acquired from a variety of sources, such as local hands-on training classes or online courses.

This is especially true for Optical Time Domain Reflectometers (OTDRs). OTDRs are complicated technical devices, requiring a great amount of technical skill, knowledge, and expertise to operate. Proper setup and trace interpretation are paramount to a successful OTDR test, and the consequences of being inadequately trained could result in a significant amount of network down-time and repair costs.

In addition, OTDRs are delicate scientific instruments, and should be treated as such. Great care should be taken to ensure that all optical ports are kept clean and free from debris. The reasons for this are two-fold: 1) a clean OTDR produces accurate and precise results; and 2) if debris is allowed to build up in the OTDR test port, over time connector insertions will grind the debris into the OTDR port endface, resulting in scratches or “pits” that require extensive and costly repairs.

Valuable information about fiber optic testing can also be gathered from reading printed literature carefully or by thoroughly reading supplied operations manuals.

The main reason to use an OTDR is to locate faults in an optical fiber that exhibits unacceptable amounts of optical loss, or is no longer functioning properly. These faults are commonly called “events” and include anomalies such as breaks, shatters, connector endfaces, patch panels, splices, macro-bends, and micro-bends. By knowing the precise distance to an event, the technician can determine the nature of the event and quickly restore the network to its former working state.

There are two types of events detectable by an OTDR: Fresnel (reflective) and backscatter (non-reflective).

Fresnel events are caused by “glass-to-air” boundaries in the optical fiber, which causes a high amount of light to be reflected directly back toward the OTDR. Common Fresnel events include breaks, shatters, connector endfaces, patch panels, or even the end of the fiber. End-of-fiber detection can also be used to measure the end-to-end length of the fiber.

Backscatter events are caused by the intrinsic properties of the optical fiber. The make-up of the optical fiber scatters the light in all directions, including a small amount that gets scattered back towards the OTDR. Common backscatter events are splices, (either fusion or mechanical), macro-bends, and micro-bends. Backscatter can also be used to measure the attenuation (loss) on a certain section of an optical fiber.

ABOUT THIS MANUAL

Throughout this manual you will find various symbols that assist with understanding the procedures outlined in this manual. Below is a list of these symbols and a short description of their purpose:



Helpful tip



Cautionary information



Potentially dangerous condition or operation

SECTION I: INTRODUCTION

DESCRIPTION

Upholding OWL's commitment to high-quality, yet affordable, fiber optic test equipment, the OWLTrek II OTDR enables fiber optic professionals to quickly and easily troubleshoot and locate optical faults in singlemode fibers.

The OWLTrek II is truly a hand-held unit, being one of the smallest OTDRs on the market today – easily able to fit into a shirt pocket – yet having capabilities of other OTDRs costing thousands of dollars more.

Optical fiber traces are displayed on a high-resolution color LCD display which implements state-of-the-art display technology to allow the OTDR's high-resolution color LCD display to "flip" between portrait or landscape mode automatically simply by rotating the device 90°. By "flipping" from portrait to landscape, the user sees a wider viewing area, displaying more trace information on the high-resolution color LCD, and allowing for greater viewing detail.

Important OTDR trace parameters such as pulse width, index of refraction, and data point averaging are fully user-configurable, and are accessible through an intuitive menu system. A minimum of 65 traces using the longest trace distance can be stored in the OWLTrek II's internal memory.

Powering the OWLTrek II is a re-chargeable Lithium-polymer battery that allows for up to 20 hours of normal usage.

The OWLTrek II is equally suited to testing singlemode fibers in many test environments, including LAN, MAN, WAN, FTTH, Telco, CATV, Manufacturing, and Laboratory.

PERFORMANCE EXPECTATIONS AND LIMITATIONS

REFLECTIVE EVENTS

Fault Location. The main function of the OWLTrek II OTDR is to detect the presence of highly reflective events, otherwise known as Fresnel events, such as breaks, shatters, patch panels, or the end of the fiber link. The distance to an event is shown as a spike on the OTDR trace, allowing the technician to quickly locate the problem and restore the network.

Fiber Length Measurement. The OWLTrek II can give the operator a general idea of the length of the optical fiber by placing the cursors at the first and last reflective events, although the last reflective event is not guaranteed to be the end of the fiber. For example, a severe enough break mid-span could prevent the OTDR from detecting other events beyond the break, or the OTDR trace could show echoes or ghosts of previous Fresnel events.

BACKSCATTER EVENTS

Backscatter Events. The OWLTrek II has some ability to locate and measure backscatter events. Tweaking pulse-width and averaging settings may enhance the OWLTrek II's ability to detect backscatter events. However, even with optimal settings, low loss backscatter events will become less detectable as the event gets farther away from the beginning of the fiber, especially on longer fibers.

Backscatter events are also more difficult to measure and interpret. Proper cursor placement is vital to the accurate measurement of backscatter events. Only individuals with OTDR training and expertise should attempt backscatter event measurement. Interpreting OTDR traces will be covered in more detail later in this manual.



Attenuation Measurement. Backscatter can be used to measure the attenuation (or loss) of certain sections of an optical fiber by placing the cursors at the beginning and end of the segment of fiber to be measured.

If available, however, a Power Meter / Light Source (PMLS) test kit or Optical Loss Test Set (OLTS) should always take precedence over an OTDR for end-to-end attenuation measurements.

SECTION I: INTRODUCTION

PRECAUTIONS

Eye Safety

-  **NEVER** look into the connector port of any fiber optic test or transmission equipment, patch cable, fiber link, or other installed fiber. Always assume that active laser equipment is attached to optical fibers, and is powered on.
-  Do not run a test on the OTDR unless it is connected to the fiber under test, or the dustcap is firmly in place.

Electrical Safety

-  Only use appropriate AC adapters for charging this device. Use of inappropriate power adapters could cause damage to the device, and could cause harm to the user from fire and electrical shock.

Operational

-  Keep connector ferrules and optical connector ports clean to prevent irreparable damage to the OTDR port. For best results, replace dust caps after each use.

Connector

-  For best results, do NOT insert APC (Angled Physical Contact) connectors into the OTDR port.

Service

-  There are no user-serviceable parts in this device. Unauthorized attempts to service this product will void the product warranty.

LABEL INFORMATION

On the back of each OWLTrek II OTDR is a label similar to the one shown here containing model number, serial number, power requirements, and special cautionary information.

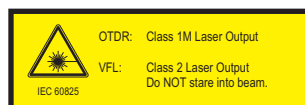

OTDR port Class 1M Laser Output
VFL port Class 2 Laser Output. Do NOT stare into beam.



USB port 6VDC, 1A



Directive 2002/96/EC of 27 January 2003 on waste electrical and electronic equipment (WEEE)

EU Directives EN 61326-1:2006 (EMC) and EN 61010-1:2001 (Safety)

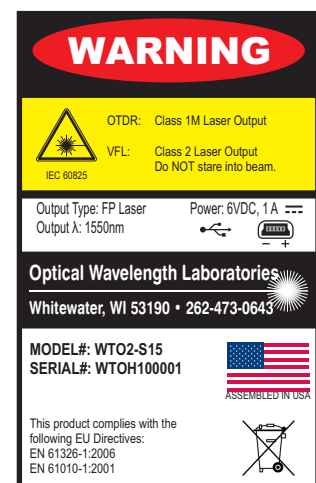

SECTION I: INTRODUCTION

PORTS

- 1 **Visual Fault Locator Port (VFL)** – Visual Fault Locator port for troubleshooting
- 2 **USB Download Port** () – downloads data from the OTDR to the PC for software trace analysis and digital data storage; also used for battery charging
- 3 **OTDR Port (OTDR)** – connects the OTDR to the fiber under test
- 4 **Reset Button** – resets the OTDR in case of malfunction

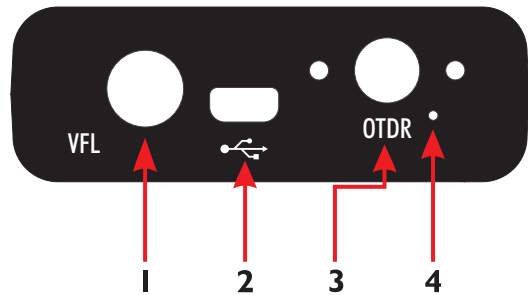

BUTTONS

- 5 **Menu Buttons** – activates the associated menu option
- 6 **Navigation Buttons** – moves cursors or menu options in the direction of the button, or are used to zoom in or out on cursor placement
- 7 **Power Button** – powers the OTDR on; press and hold to power off; also, while the OTDR is on, brief press will activate other functions
- 8 **Enter Button** – from the trace screen, this button changes the function options menu at the bottom of the screen. Also activates menu options while in the menu system



SECTION I: INTRODUCTION

DISPLAY

- 9 Fiber ID – name of the currently loaded fiber trace
- 10 OTDR Test Mode – shows which test mode the OTDR is in – AUTO, USER, SEMI, or FILT
- 11 VFL Indicator – shows the current VFL mode: blank = OFF; red = ON continuous; pink = ON flashing
- 12 Zoom Indicator – displays “H” for horizontal zooming, and “V” for vertical zooming
- 13 Battery Life Indicator – displays the remaining battery life
- 14 Trace Viewing Area – displays the results of the OTDR trace(s), which users can zoom in on for more detailed trace analysis
- 15 Trace Wavelength – shows the wavelength(s) of the traces displayed in the trace viewing area. The active trace wavelength will be listed on the left.

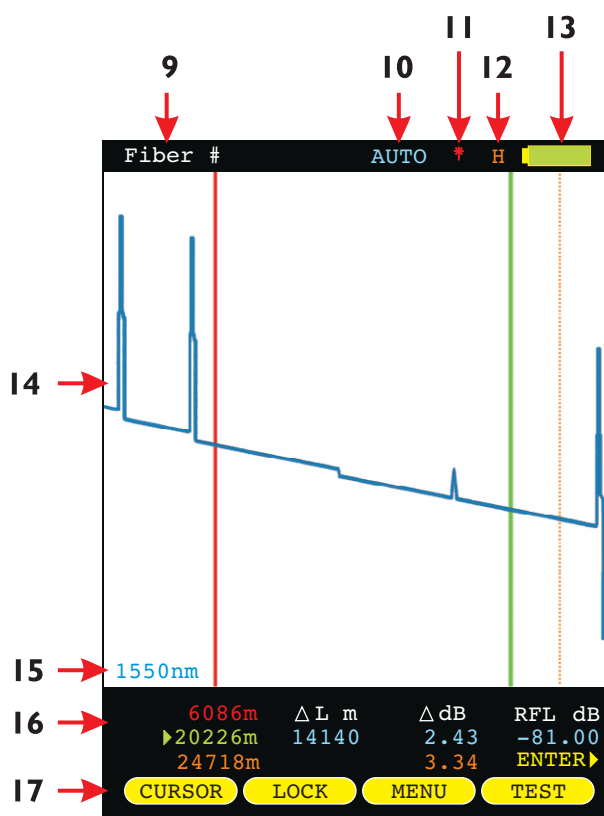

If more than one wavelength is present, the color of the trace corresponds with the color of the wavelength number

- 16 Trace Information – displays the relative position and power levels at and between the red and green cursors for the currently active trace.
- 17 Function Options Menu – displays the on-screen menu options for trace control

There are three sets of Function Options Menus. The Enter key (↵) is used to toggle between these three menus:



NOTE: the WAVE option will only be displayed if more than one wavelength is present

SECTION I: INTRODUCTION

INDICATOR LEDs

18 **CHARGING STATUS** – will be lit when charging through a transformer or USB port

GREEN battery fully charged

ORANGE battery charging

RED problem with battery and/or charger; contact OWL for service

19 **STANDBY STATUS**

Normal operation **GREEN** blinking

STANDBY **RED** solid; press any key to “wake up” the device

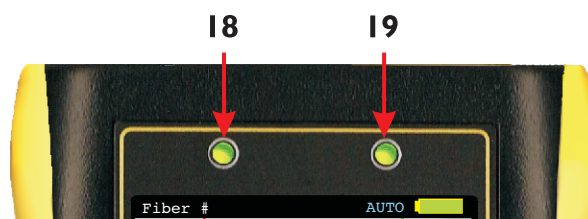

SECTION 2: OTDR TESTING

POWER ON/OFF

POWER ON

Press  to power on the OTDR.

When the OTDR has completed startup, the trace area will either be blank, as shown at right, or will show the previously viewed trace.

Continue below for more information about running a new OTDR trace.

POWER OFF

The OTDR may be powered off from any screen by holding .

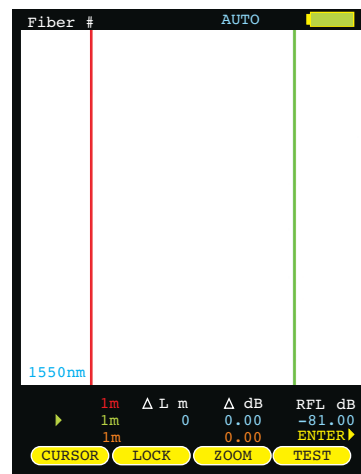

KEY OTDR TRACE PARAMETERS

Below is a descriptive list of key OTDR trace parameters.

WAVELENGTH – range of values: **Multimode: 850, 1300, BOTH; Singlemode: 1310nm, 1550nm, BOTH.** Allows the user to select one or two wavelength(s) used for testing. Wavelength selection only applies to dual-wavelength OTDR.

INDEX OF REFRACTION – range of values: **1.4000 to 1.6000.** To ensure the most accurate distance to events, Index of Refraction (IoR) should be set to the fiber manufacturer's refractive index specification for the fiber under test. If unknown, set IoR to:

SINGLEMODE – 1.4681 (as this value falls within 99% of the IoR values for most singlemode optical fibers)

MULTIMODE – 1.4920

CAPTURE MODE – range of values: **AUTO, SEMI, USER, FILT, LIVE.**

AUTO all trace options are determined automatically, except dead zone length.

SEMI same as AUTO except the pulse width is not automatically determined.

USER all user configured options are used when capturing the trace.

FILT same as USER plus the software will filter (smooth) the trace to remove noise. This will help produce a cleaner trace with less averaging required.

LIVE uses the user-defined trace settings to continuously update the trace on the screen. The trace will be updated after the user-defined number of averages is completed. The cursors and zoom functions work in LIVE mode. To start and exit LIVE mode, press the TEST function button.

NOTE: if connected to a PC running OWLView software, LIVE mode also updates the software trace area

PULSE WIDTH – range of values: **Multimode: 1, 2, 5, 10, 20, 50, 100 m; Singlemode: 1, 2, 5, 10, 20, 50, 100, 200, 500, 1000 m.** Pulse width offers a trade-off between the ability to measure longer cable distances (longer pulse width) versus the ability to see two events that are closely spaced (shorter pulse width). This is otherwise known as an OTDR's event dead zone (i.e. the minimum distance between two events where they both can be measured).

NUMBER OF SAMPLES – range of values: **256, 512, 1024, 2048, 4096.** Increasing the number of samples allows the OTDR to have better display resolution (events are easier to see, especially near the noise level), but also increase the trace acquisition time.

DEAD ZONE LENGTH(m) – range of values: **0 to 1500.** Allows the user to enter the length of a dead-zone box (a.k.a. pulse suppressor), if one is being used. If a value is entered for dead zone, the dead zone portion of the OTDR trace will be grayed out. The active portion of the trace will begin where the dead zone ends.

RANGE – range of values: **1, 2, 5, 10, 25, 50, 65, 128 km.** Allows the user to manually enter the total length of the trace. NOTE: for best results, this value should be set to the next highest value from the actual length of the fiber under test.

STEP – range of values: **1, 2, 4 m.** Trace sample spacing. Smaller steps produce more accurate distance to events, but trace acquisition takes longer.

SECTION 2: OTDR TESTING

SETTING TEST PARAMETERS

SET WAVELENGTH

When using a dual-wavelength OTDR, traces can be run at either one or two wavelengths.

To set the trace wavelength(s), press  from the trace screen until the following menu options appear:



allows the user to select one or both wavelengths to be used for testing. Arrow keys scroll through three options: 1310nm, 1550nm, BOTH. Press key again to exit.

The selected wavelength(s) will appear at the bottom of the trace screen. If two wavelengths are present on the trace screen, they will be displayed as either blue or brown.

The cursor information below the trace screen applies to the wavelength listed in blue.

 If the OTDR only has one wavelength installed, the WAVE option will not appear.

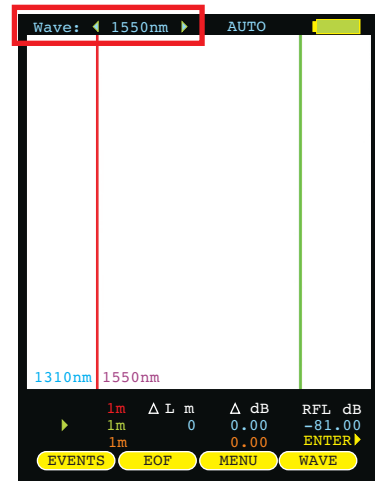

SET INDEX OF REFRACTION

To set the index of refraction, press  from the trace screen until the following menu options appear:



allows the user to change the index of refraction; setting will appear at the top of the trace screen. Press key again to exit.

Index of refraction should be set to the optical fiber manufacturer's index of refraction specification. If unknown, use the suggested values below.

Suggested index of refraction values:

SINGLEMODE – 1.4681

MULTIMODE – 1.4920

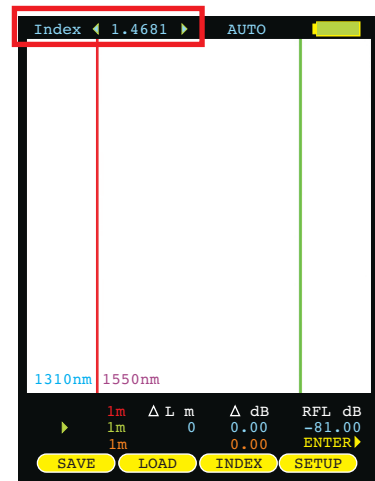

SECTION 2: OTDR TESTING

SETTING TEST PARAMETERS, cont.

SETTING TRACE OPTIONS

To see an additional menu of trace options, press  from the trace screen until the following menu options appear:



 opens the TRACE OPTIONS menu



selects the next or previous trace option



changes the value in the selected trace option

CAPTURE MODE – Range of values: AUTO, SEMI, USER, FILT, LIVE

Capture Mode should be set to **AUTO** mode for a majority of testing scenarios, so the OTDR can automatically determine the best set of trace parameters based on the fiber link under test.



USER, SEMI, FILT, and LIVE require the user to understand the consequences of setting trace parameters manually.

Only trained fiber optic professionals who are experienced with operating OTDRs should manually set trace parameters. Suggestions for setting these parameters are given below.

PULSE WIDTH – range of values: **Multimode: 1, 2, 5, 10, 20, 50, 100 m; Singlemode: 1, 2, 5, 10, 20, 50, 100, 200, 500, 1000 m.** Pulse width should be set to the shortest setting that allows multiple closely-spaced events to be clearly defined, while preventing any of the trace from reaching the noise floor.

NUMBER OF SAMPLES – Range of values: **256, 512, 1024, 2048, 4096.** Use the maximum number of samples unless traces are taking too long to acquire.

DEAD ZONE LENGTH (m) – Range of values: **0 to 1500.** Set this value to '0000' if not using a dead-zone box (a.k.a. pulse suppressor box). If using a dead-zone box, and you want to highlight the dead-zone box length on the trace, enter the length of the dead-zone box in meters.

RANGE – range of values: **1, 2, 5, 10, 25, 50, 65, 128 km.** Set to the next highest value from the actual length of the fiber under test. If fiber length is unknown, select MAX km.

STEP – Range of values: **1, 2, 4 m.** Use shortest STEP value for most accurate distance to events, unless trace acquisition time is too long.

TRACE OPTIONS	
CAPTURE MODE	AUTO
PULSE WIDTH	1m
NUMBER OF SAMPLES	4096
DEAD ZONE LENGTH (m)	1100
RANGE	MAXkm
STEP	1m

SAVE QUIT HELP

SECTION 2: OTDR TESTING

STARTING AN OTDR TRACE

Once the OTDR parameters have been set, an OTDR trace can be run. Press  from the trace screen until the following menu options appear:



 starts an OTDR trace based upon the current OTDR parameters

During the OTDR test (as shown at right):

- the ABORT soft-key appears (used to abort an OTDR trace)
- all soft-keys are disabled
- a bar graph appears at the top of the screen showing the progress of the OTDR test
- dual-wave test will run a separate trace automatically for each wavelength

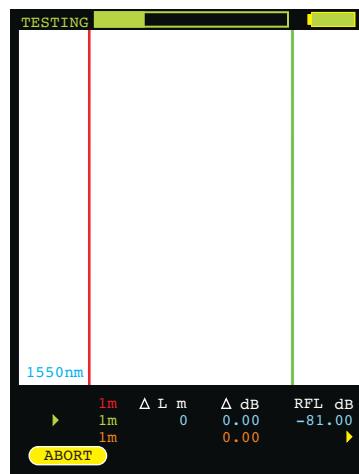

- ✓ starting a new trace will replace the old trace on the display with the new trace after a few seconds (depending upon the trace length).

CURSOR NAVIGATION

Once the OTDR trace is complete, the OTDR trace will appear on the screen, and the OTDR information – distance and optical power – will be updated.

- ✓ two color coded traces will appear on the screen if a dual-wavelength trace was run

Trace information is color-coded. Red and green refer to the cursors. Blue text refers to the difference between the two cursors. Orange text refers to the perceived end of the fiber link.

 sets the active cursor – no cursor, red, green, or both red and green

 locks the active cursor at its current location; unlocks a locked cursor

When a cursor is locked, a colored padlock symbol will appear next to the appropriate cursor information

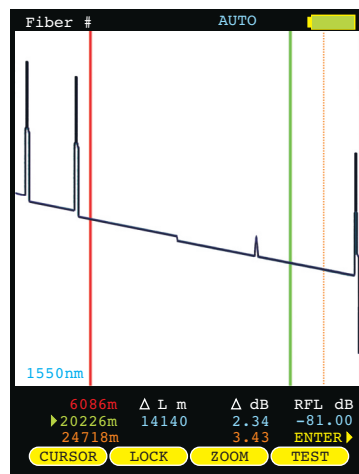

 sets the ZOOM mode to Horizontal (H) or Vertical (V)

  **WHEN ONE OR MORE CURSORS ARE SELECTED:** moves the cursor(s) left or right; holding these buttons speeds up the cursor movement

WHEN NO CURSOR IS SELECTED: screen pans left and right

  **WHEN ONE OR MORE CURSORS ARE SELECTED:** zooms in or out on the active cursor(s)

WHEN NO CURSOR IS SELECTED: zooms in and out on the center of the screen

SECTION 3: TRACE ANALYSIS

OVERVIEW

This section will provide a basic overview about how to analyze an OTDR trace, and will cover the different types of information that can be gathered from an OTDR trace, including:

- event location;
- fiber length measurement;
- fiber attenuation (loss); and
- reflectance measurement.



proper interpretation of OTDR test results requires a significant amount of technical skill, knowledge, and expertise. Proper trace interpretation is paramount to a successful OTDR test, and the consequences of interpreting a trace incorrectly could result in a significant amount of network down-time and repair costs.

EVENTS

The primary function of an OTDR is to locate events along the optical fiber. On an OTDR trace, events appear as deviations from an otherwise gently sloping line.

Below is a list of the different events shown in the example at right, including the type of event, and possible interpretations of the data:

- | | | |
|----------|-------------|---|
| 1 | Fresnel | end of dead-zone box (pulse suppressor) |
| 2 | Fresnel | patch panel using flat polish connectors |
| 3 | Backscatter | fusion splice or macro-bend |
| 4 | Fresnel | patch panel using APC (angled physical contact) connectors |
| 5 | Fresnel | end of fiber link; could also indicate a severe break where no other events can be detected after the break |

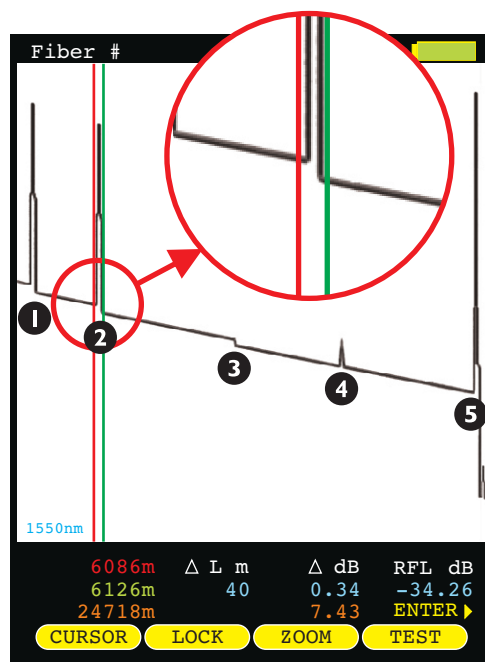

If the slope of the trace appears to “dip” to a lower level after the event (events 1, 2, and 3), this could mean one of two things: 1) if the slope of the line changes, the refractive index of the fiber preceding the event is different from the refractive index of the fiber following the event, or 2) if the slope stays the same, then the event is simply a loss-inducing event.



Tall spikes usually indicate flat polish connections or other highly reflective events (breaks, shatters, end of fiber, etc.), while short spikes usually indicate angled polish connections.

CURSOR PLACEMENT

Proper cursor placement is critical in determining the exact distance to an event, as well as the relative effect the event has on optical power traveling through the event.

The **red** cursor should be placed right before the slope of the line begins to spike.

The **green** cursor should be placed after the event, at a point where the slope of the line returns to the normal backscatter level.

The trace information (located below the trace) will show the distance and relative power (in dB) at the point where each cursor is placed.

SECTION 3: TRACE ANALYSIS

FIBER LENGTH MEASUREMENT/LINK LOSS

By placing the cursors at the beginning and ending points of the fiber trace, the distance between the cursors will show a close approximation of the total length of the optical fiber link, as well as a close approximation of the total fiber link loss.

CURSOR PLACEMENT

Proper cursor placement is necessary to determine the end to end length and link loss of an optical fiber link. Refer to the diagram at right when placing cursors for fiber length measurement.

The **red** cursor should be placed directly before the first reflective event, before the slope of the line begins to spike.

The **green** cursor should be placed directly before the last event, before the slope of the line begins to spike.

The trace information (located below the trace) will show the distance and relative power (in dB) at the point where each cursor is placed, as well as the total link distance and end-to-end link loss.

In this example, the total link length is **24718 meters**, and the end-to-end link loss is **7.43 dB**.

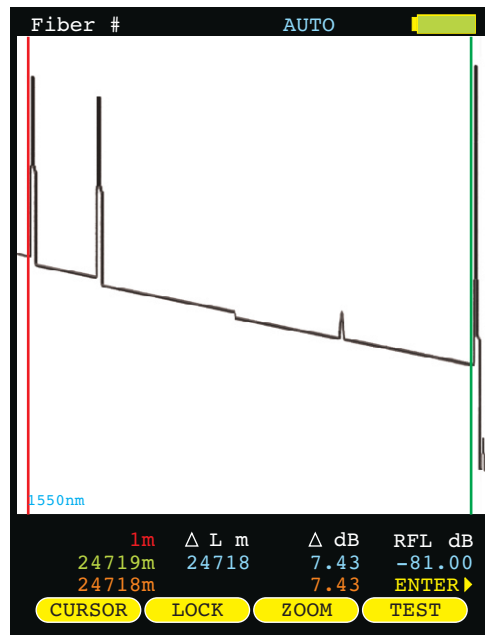

FIBER ATTENUATION MEASUREMENT

The fiber attenuation, or loss, for a certain section of an optical fiber link can be determined by placing the cursors at the beginning and end points of the segment of fiber under test.

CURSOR PLACEMENT

Proper cursor placement is necessary to determine the attenuation of a certain segment of fiber.

The **red** cursor should be placed at the beginning of the section of fiber under test.

The **green** cursor should be placed at the end of the section of fiber under test.

The trace information (located below the trace) will show the distance and relative power (in dB) at the point where each cursor is placed, as well as the loss and distance of the section of fiber being analyzed.

In this example, the section of fiber being analyzed has **1.76 dB** of loss, and is **7040 meters**.

Using this information, dB per kilometer can also be calculated, which can be compared to the fiber manufacturer attenuation specification. To determine dB/km:

$$1.76 \text{ dB} / 7.040 \text{ km} = 0.25 \text{ dB/km}$$

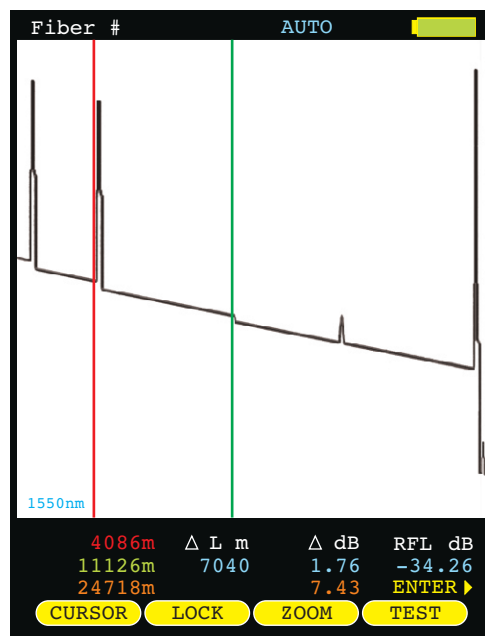

In the example shown here, the attenuation measurement also includes the loss through the connector located near the red cursor.

SECTION 3: TRACE ANALYSIS

REFLECTANCE MEASUREMENT

The reflectance of a specific event can be determined by placing the cursors on either side of an event. The OTDR will show the reflectance in dB of the highest reflective event between the cursors.

CURSOR PLACEMENT

Proper cursor placement is important when determining the reflectance of a reflective event.

The **red** cursor should be placed on the backscatter line directly before the event, on the sloping line before the spike.

The **green** cursor should be placed on the backscatter line somewhere after the event.

- ✓ Make sure that only one reflective event is included between the cursors.

The trace information (located below the trace) will show the reflectance (in dB) of the highest reflective event between the cursors.

In this example, the reflective event being measured has a reflectance of **-34.26 dB**.



TRACE EVENTS MENU

Automatic event location can be performed from the trace screen by accessing the **EVENTS** function option. See page 5 for more information about function option menus.

- ⓘ **IMPORTANT NOTE: automatic event location is only meant to be used as a guideline for the location of possible events. It is ultimately up to the user to verify and determine if an event actually exists at that location.**

- LOCATION** the distance to the start of the event
- TYPE** type of event (reflective, loss, etc.)
- REFL** reflectance of the event
- LOSS** loss of the event

TRACE EVENTS			
Location	Type	Refl	Loss
▶ 14m	REFL	-47.38	0.87
24011m	LOSS	-81.00	0.21
50539m	REFL	-17.54	-11.63

At the bottom of the screen are four buttons: VIEW, PAGE, DONE, and a blank button.

- ▲ ▼ moves the cursor up and down in the list of detected events
- VIEW** returns the user to the trace screen, zoomed in on the selected event
- PAGE** displays the next page of events, if there are more events than will fit on the screen
- DONE** returns the user to the trace screen

Once an event has been selected from this menu, each individual event will be marked with a “tic” mark at the top of the trace area. The type of event is denoted by color: **black** for loss events and **light blue** for reflective events.

SECTION 3: TRACE ANALYSIS

SATURATION INVERSION

Some highly reflective events are so reflective that they “over-drive” the OTDR circuitry, and cause the OTDR graph to appear as if the trace completely drops out.

This issue is called “saturation inversion”, and only appears when overly-reflective light causes the internal OTDR circuitry to become saturated.

Every OTDR suffers from saturation issues, and many high-end OTDRs include additional circuitry that tries to quench the saturation as it occurs.

However, irregardless of how well an OTDR can quench the saturation, the fact remains that the reflective event requires immediate attention.

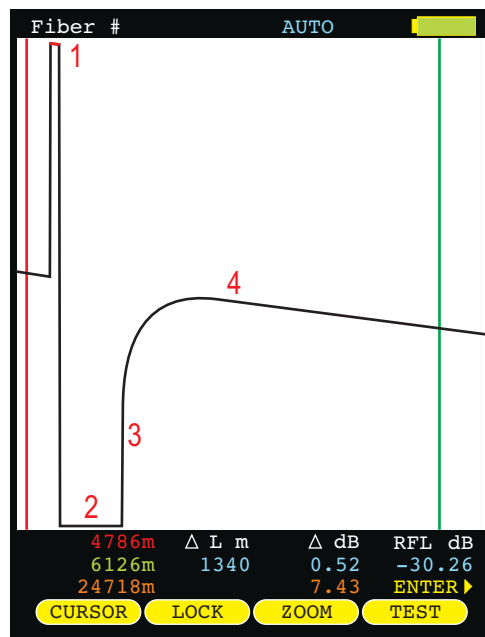

TRACE ANALYSIS

The sample trace shown here shows what typical saturation inversion looks like. Four key points have been noted on the trace to explain what is occurring in the OTDR:

- 1) The red line at the top of the reflective peak shows that the OTDR has been saturated (please note that when the peak has a red line, the reflectance value is not being reported properly);
- 2) The flat line at the bottom of the trace shows that the OTDR has been “over-driven”, and has inverted the trace;
- 3) The OTDR has begun its recovery from saturation;
- 4) The OTDR has fully recovered from saturation, and has returned to its normal backscatter line.

In this example, the reflective event is caused by the interconnection that occurs between two connectors at a patch panel. The connectors on either side of the patch panel are PC (physical contact).

There are several ways to address highly reflective events like this:

- a) Thoroughly clean and inspect both connectors for debris or damage;
- b) If the connectors appear damaged after thorough cleaning, try re-polishing the connector endfaces;
- c) Re-terminate using connectors with better reflectance values (typical values shown here);

PC (physical contact)	-30 to -35 dB
UPC (ultra physical contact)	-45 to -50 dB
APC (angled physical contact)	-55 to -60 dB (or less)
- d) Replace the mating sleeve in the patch panel.

Once the inverted event has been fixed, re-test the fiber to ensure the event is no longer overly reflective.

ANOTHER HELPFUL TIP

Another helpful tip for mitigating reflectance comes from the Fiber Optic Association (FOA) website:

http://www.jimhayes.com/OTDR/otdrs_d.htm

found under the section titled *This "Trick" Can Help*. This tip refers to the use of index-matching fluid between connectors to help eliminate the air gap causing the overly reflective event.

SECTION 4: TRACE STORAGE

STORED READINGS



sets the Function Options Menu to allow access to Data Storage and Setup Menu options. The following soft-keys apply to data storage functions.



SAVING A TRACE



LOADING A PREVIOUSLY STORED TRACE



SAVING A TRACE

Traces may be stored in permanent memory for later viewing or download to hard disk for data file retrieval.

From the trace screen, press  to enter the fiber name and save the currently displayed trace to memory.

To enter a fiber name, use the arrow keys to highlight the appropriate character on the grid.



BACKSPACE



TOGGLE BETWEEN UPPER AND LOWER CASE ALPHABET



FORWARD SPACE



SELECT THE HIGHLIGHTED CHARACTER



FINISHED ENTERING NAME

SECTION 4: TRACE STORAGE

LOADING A PREVIOUSLY STORED TRACE

Previously stored traces can be loaded from memory for later on-screen analysis.

The STORED TRACE menu may be accessed two ways:

- 1) from the Function Options menu on the trace screen, press **LOAD** ; or
- 2) select the STORED TRACES option from the SETUP MENU.



moves the cursor up and down in the list of stored traces



exits the STORED TRACES menu and returns to the trace screen



accesses context-sensitive help



loads the currently selected fiber trace into the trace screen



allows the user to overlay a previously stored trace on top of the currently loaded trace. Only one trace can be overlaid at a time, and the overlay trace is denoted by a dark arrow to the right of the trace information. Press this button again to clear the overlay status



gives the user the option: 1) to delete the currently selected fiber trace; 2) to not delete the selected trace; 3) to delete all traces; or 4) delete only traces that have been previously downloaded (see TRACE DOWNLOAD STATUS below)



displays the next page of fiber traces if there are more traces than will fit on the screen

STORED TRACES		
Trace Name	Date	Time
SM-BB-F1-F2:1	10/05/09	04:16PM ✓
SM-BB-F1-F2:2	10/05/09	04:17PM
SM-BB-F1-F2:3	10/05/09	04:19PM
SM-BB-F1-F2:4	10/05/09	04:21PM
SM-BB-F1-F2:5	10/05/09	04:24PM
SM-BB-F1-F2:6	10/05/09	04:27PM

Trace Parameters
n=1.4681 L=33600 P= 10us S=1m

ABORT HELP
LOAD OVERLAY DELETE PAGE

Overlay status column
Download status column

TRACE PARAMETER INFORMATION. Information at the bottom of the STORED TRACES screen shows trace parameter settings used when the trace was taken:

- n** index of refraction
- L** fiber length
- P** pulse width
- S** step



TRACE DOWNLOAD STATUS. If the trace has already been downloaded to the PC, this trace will be marked by a green checkmark which appears at the right of each trace.

SECTION 5: OTDR SETUP

MENUS

To access the SETUP MENU, either press **MENU** or .

NAVIGATING THE MENU SYSTEM

The arrow keys are used to navigate throughout the various menus and help screens in the OTDR. Green selection arrows highlight different menu options.



moves the selection arrows to the next or previous menu option



jumps to the highlighted menu option



returns to the previous menu



exits the menu system

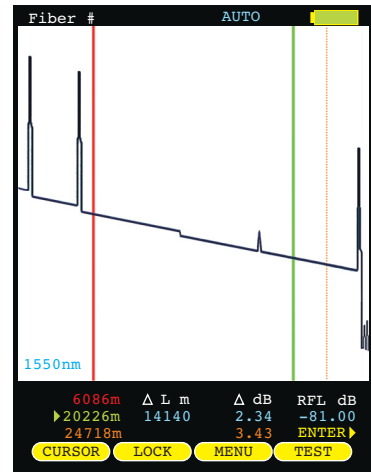

SETUP MENU

The SETUP MENU is the main entry point into the OTDR menu system. Shown below is a tree of menu options.

Each option will be explained in detail on the following pages.

HELP TOPICS

The OWLTrek II includes a built-in help menu that can be accessed from the SETUP MENU. Context-sensitive help can also be accessed from various operational and menu screens throughout the OTDR.

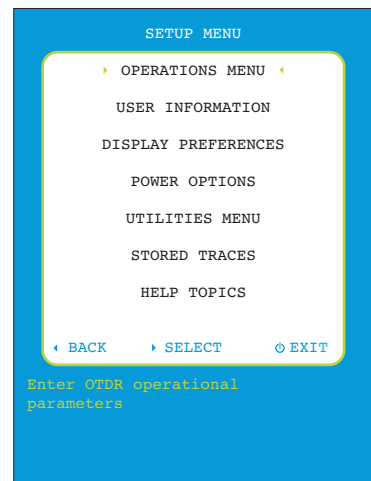

SECTION 5: OTDR SETUP

OPERATIONS MENU

OPERATIONS MENU

- TRACE PARAMETERS
- CONFIGURE OPTIONS
- SET BACKSCATTER COEFF.
- SET LENGTH UNITS
- SYSTEM INFORMATION

◀ BACK ▶ SELECT ◻ EXIT

Configure trace capture Parameters

CONFIGURE OPTIONS

Enables the 2kHz tone and visual fault locator functions, if available.

CONFIGURE OPTIONS

FIBER ID TONE: **OFF**

VISUAL FAULT LOCATOR: **OFF**

Press ENTER when done
Press ◻ for help

SET BACKSCATTER COEFFICIENT

TRACE OPTIONS

CAPTURE MODE **USER**

PULSE WIDTH **10us**

NUMBER OF SAMPLES **4096**

DEAD ZONE LENGTH (m) **1100**

RANGE **MAXkm**

STEP **1m**

SAVE **QUIT** **HELP**

Backscatter coefficient is a measure of the backscatter properties of the fiber under test, and is provided by the fiber manufacturer.

Backscatter coefficient is important in accurately determining reflectance measurements in the OTDR.

SET BACKSCATTER COEFFICIENT

Bns : -81.00

^ UP v DOWN ENTER=DONE

The fiber backscatter coefficient is a normalized measure of the backscatter properties of the fiber and is provided by the manufacturer.

TRACE OPTIONS

See page 6 for more information on trace options.

SECTION 5: OTDR SETUP

OPERATIONS MENU

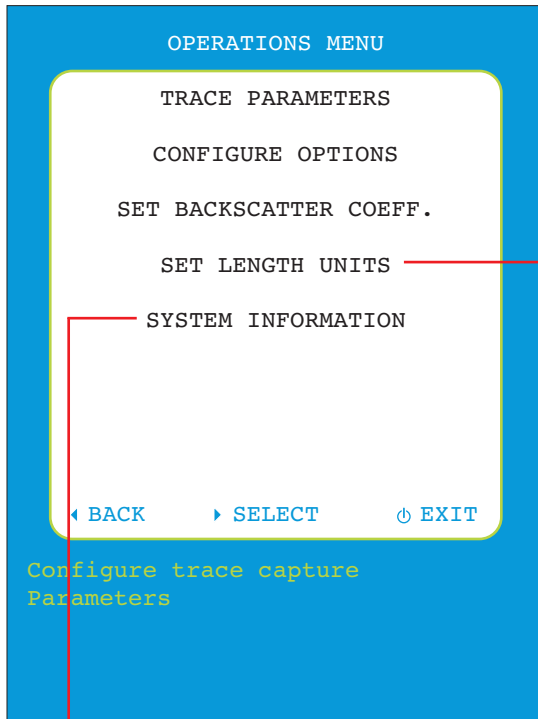

SET LENGTH UNITS

Use left and right arrow buttons to toggle length units between meters and feet.

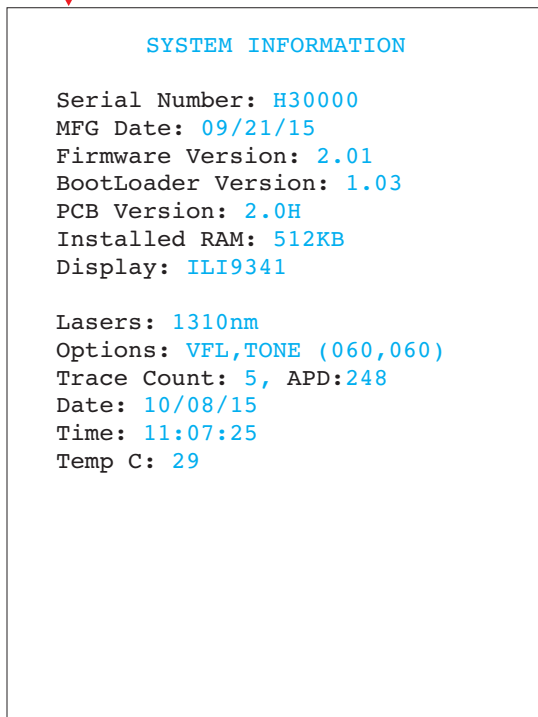
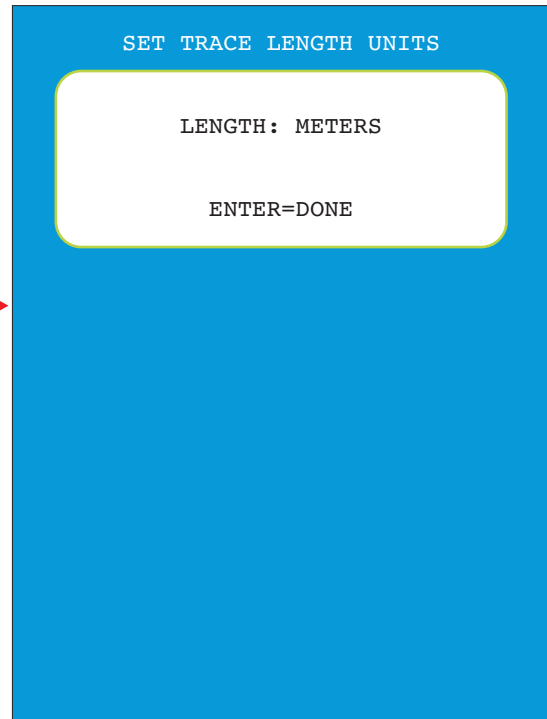

SYSTEM INFORMATION

Shows key system information about the OTDR.

SECTION 5: OTDR SETUP

USER INFORMATION MENU

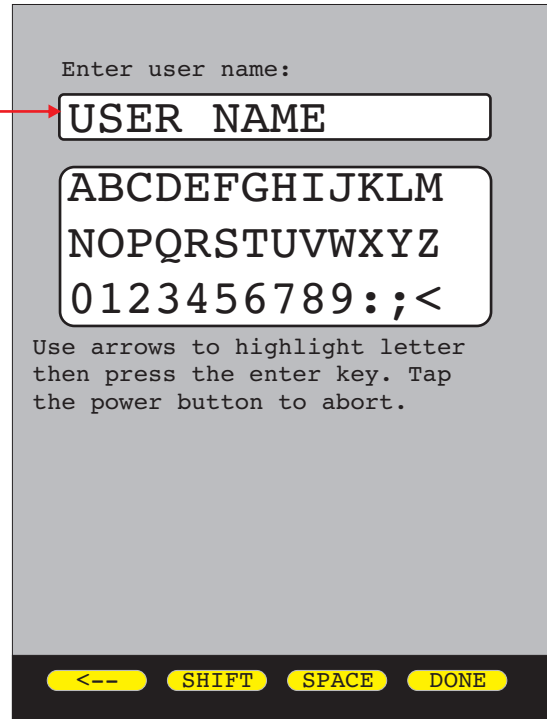
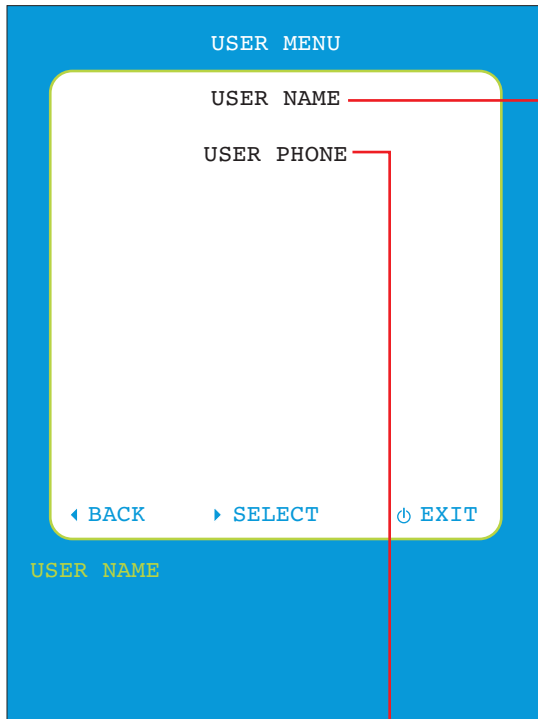

Enter user name:

Enter the name of the person or company who owns the OTDR. This information will appear on test reports.

Up to 16 characters are allowed in the user name entry field.

See the on-screen instructions for help with text entry.

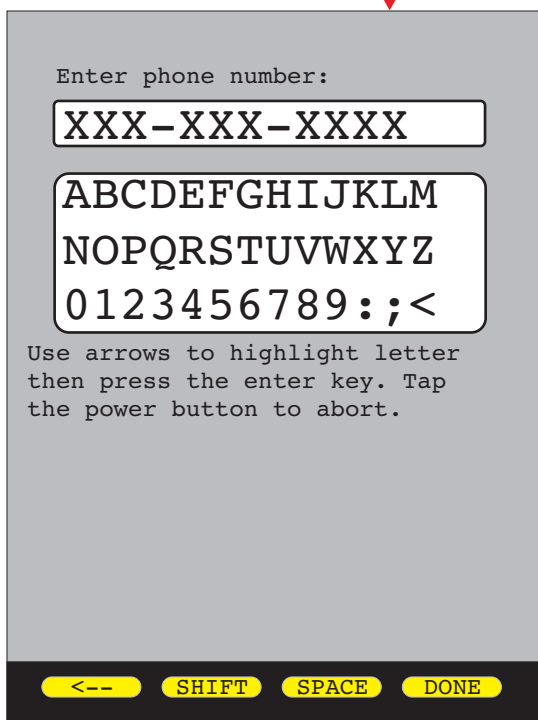

Enter phone number:

Enter the phone number of the person or company who owns the OTDR. This information will appear on test reports.

Up to 13 characters are allowed in the phone number entry field.

See the on-screen instructions for help with text entry.

SECTION 5: OTDR SETUP

DISPLAY PREFERENCES

The screenshot shows a blue menu titled "DISPLAY OPTIONS" with the following settings:

- MODE: **FLIP**
- DIMNESS: **063**
- BRIGHTNESS: **255**
- SPEAKER: **ON**
- TRACE CLIPPING: **ON**

At the bottom of the menu are three yellow buttons: **SAVE**, **QUIT**, and **HELP**.

MODE:
Sets the orientation of the LCD display. Three modes are available:
FLIP LCD automatically alternates between portrait and landscape modes based upon the physical orientation of the OTDR
PORTRAIT display is always in portrait mode
LANDSCAPE display is always in landscape mode

DIMNESS:
Sets the level of the LCD backlight during power saving mode. Range of values are 25 (dimmest) to 125 (brightest).
NOTE: higher values require more battery power

BRIGHTNESS:
Sets the level of the LCD backlight during normal operation. Range of values are 150 (dimmest) to 255 (brightest).
NOTE: higher values require more battery power

SPEAKER:
Toggles the internal speaker either ON or OFF.

TRACE CLIPPING:

Toggles trace clipping mode either ON or OFF.

On a normal OTDR trace, as the sloping line of the trace approaches the noise floor of the OTDR, the trace starts becoming less smooth, making events harder to see near the end of the trace.

Trace clipping is a method that “clips” the top of the most reflective peaks, in order to draw the sloping line away from the noise floor. This effectively smooths out the trace, allowing smaller events to be more easily detectable.

While trace clipping is ON, reflectance measurements of clipped events are not affected.

SECTION 5: OTDR SETUP

POWER OPTIONS

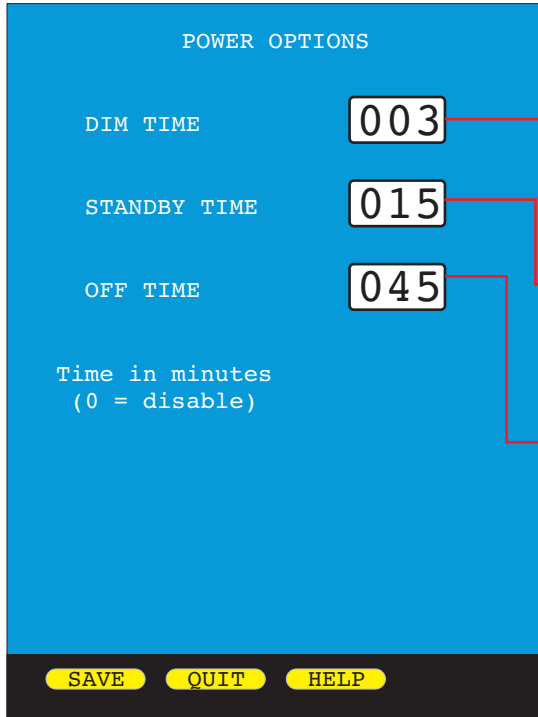

DIM TIME:

Sets the time (in minutes) before the display will enter DIM mode. Range of values is 1 to 250.

STANDBY TIME:

Sets the time (in minutes) before the OTDR will enter STANDBY mode. Range of values is 2 to 250.

OFF TIME:

Sets the time (in minutes) before the OTDR will power off. Range of values is 3 to 250.

SECTION 5: OTDR SETUP

UTILITIES MENU

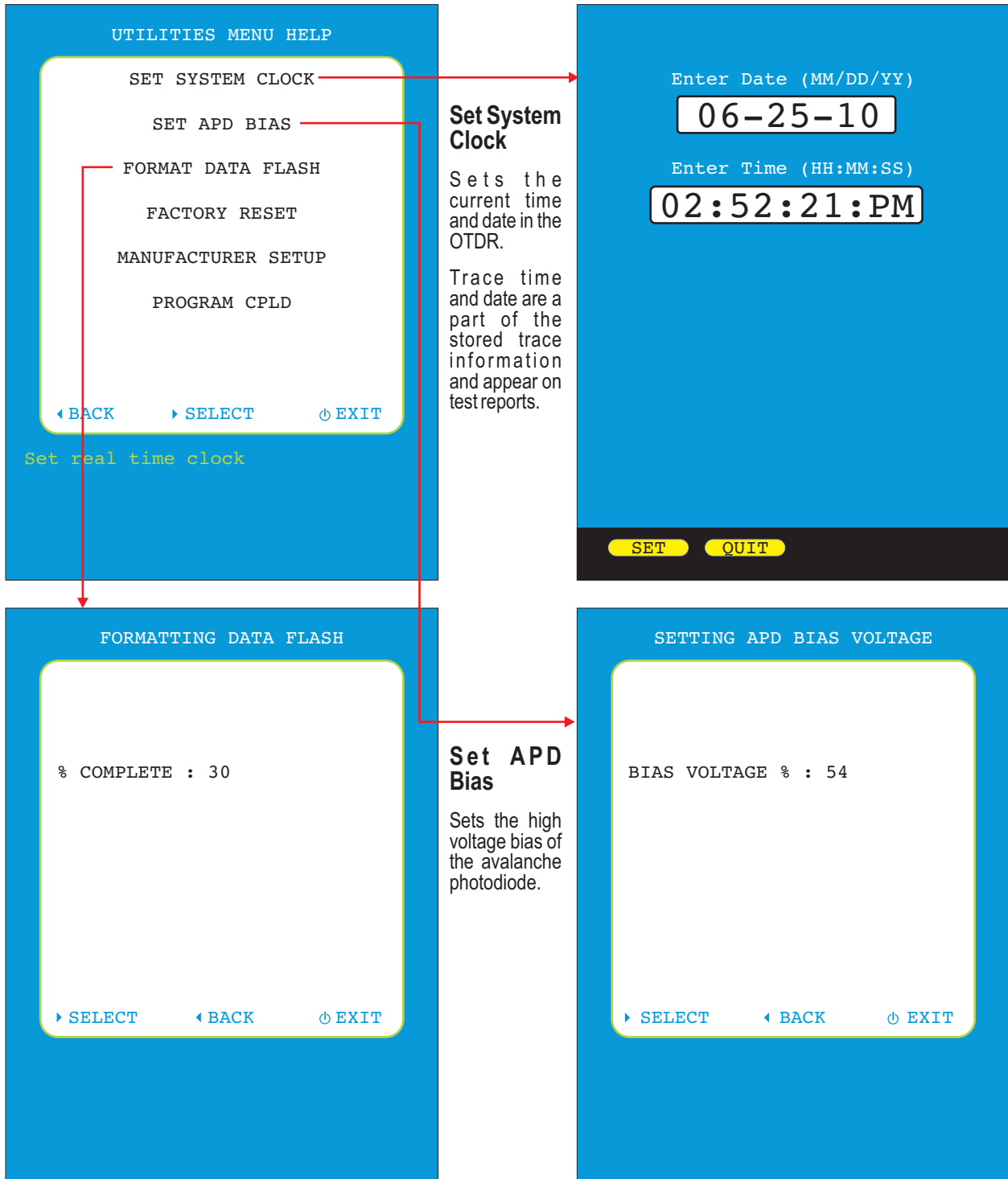

Format Data Flash

Initializes the internal trace storage memory. This option will erase all stored traces, and should only be used in cases where the file system has become corrupted.

SECTION 5: OTDR SETUP

UTILITIES MENU, CONT.

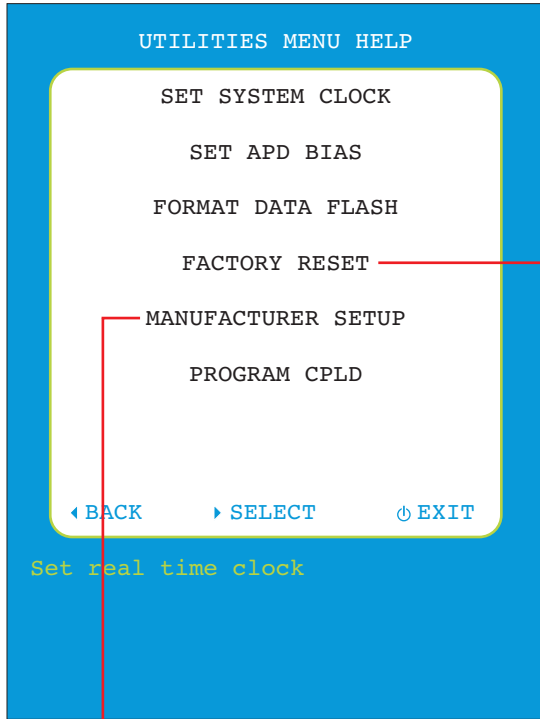

Manufacturer Setup

Contains setup parameters accessible by the manufacturer only.

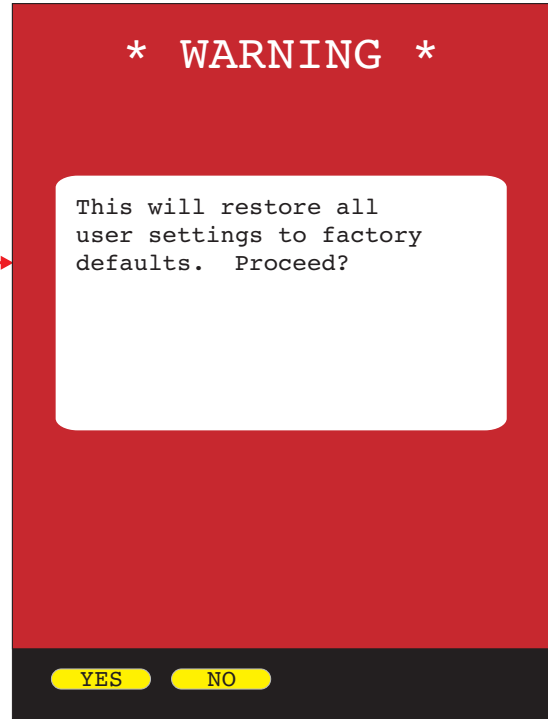

Factory Reset

Restores user settings to factory defaults.

SECTION 6: OPERATION/MAINTENANCE

VISUAL FAULT LOCATOR (VFL) OPERATION

The OWLTrek II OTDR contains a visual fault locator port used for quick troubleshooting of optical faults close to the near-end of the optical fiber under test.

The 2.5mm universal VFL port is located on the left-hand side on the top of the OTDR.

OPERATING THE VFL

Press the Enter key () until the MENU function option appears.



Press the VFL soft key to toggle through the different VFL modes.

The VFL status icon will appear on the trace screen above the trace area as shown at right:

(no icon) OFF



ON



BLINK

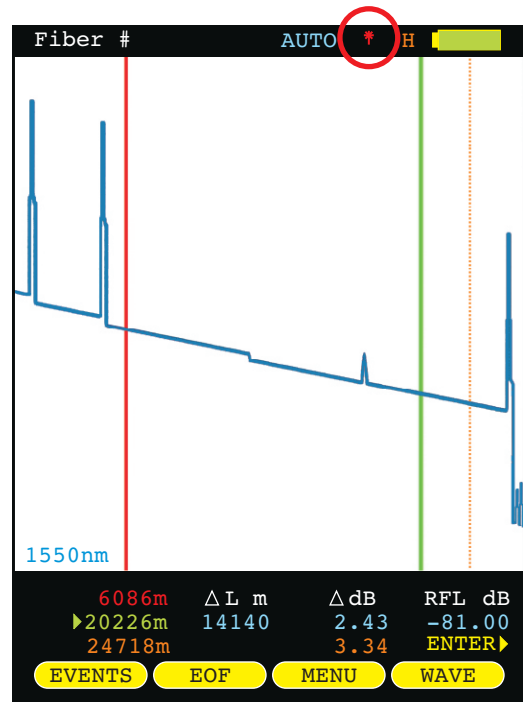

EYE SAFETY PRECAUTIONS



NEVER look directly at the output of the VFL, and even limited exposure over time to reflected VFL light can be dangerous to the eye.



For best results if using the VFL for end-to-end fiber identification, use a piece of paper to diffuse the light exiting the far-end connector.

SECTION 6: OPERATION/MAINTENANCE

FIBER ID TONE OPERATION

The laser output of the OTDR port can be used to produce a 2kHz tone for use with fiber identifiers.

SETTING THE FIBER ID TONE

Press the Enter key () until the MENU function option appears.
From the SETUP MENU, follow the menu path below:

SETUP MENU >> OPERATIONS MENU >> CONFIGURE OPTIONS



From the CONFIGURE OPTIONS menu, highlight the FIBER ID TONE option. FIBER ID TONE has two settings: OFF and ON.

The FIBER ID TONE status icon () will appear on the trace screen above the trace area as shown at right.

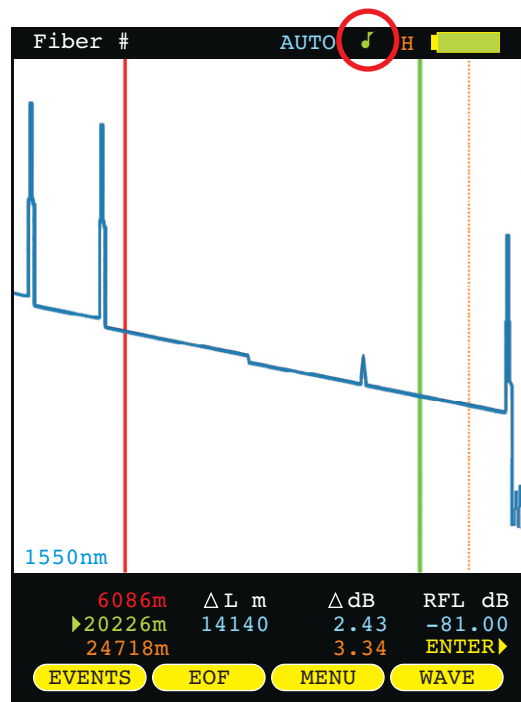
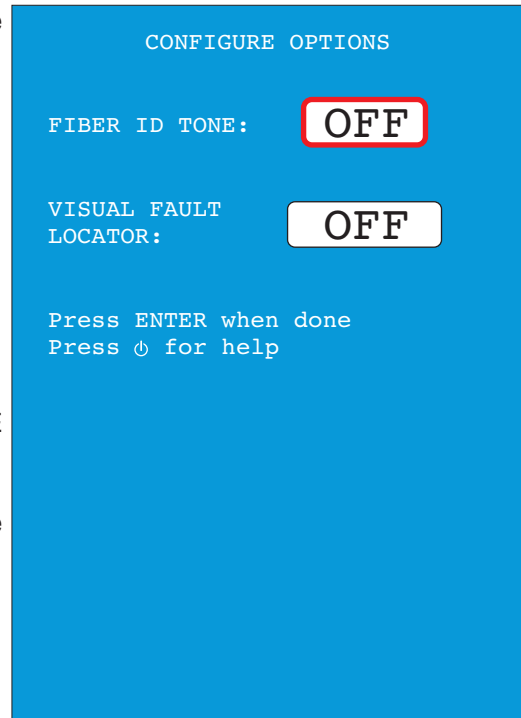

SECTION 6: OPERATION/MAINTENANCE

LIVE MODE OPERATION

LIVE MODE is an advanced feature that periodically updates the OTDR screen while the OTDR is taking a trace, in order to view events as they happen in real-time.

LIVE MODE OPERATION

Press  from the trace screen until the following menu options appear:



 opens the TRACE OPTIONS menu

  highlight CAPTURE MODE



  change the value to LIVE

Press SAVE to return to the trace screen. The function menu should show:



Press  to start LIVE mode. After a few seconds the OTDR screen will acquire its initial trace.

After acquiring its initial trace, the trace screen will begin to update every few seconds.

-  The frequency of screen updates will depend upon the selected TRACE OPTIONS. Lowering the number of samples and/or increasing the STEP value will increase the frequency of screen updates, but will also lower the trace resolution.
-  If the screen does not appear to be changing, the characteristics of the fiber are not changing.
-  When the OTDR is connected to a PC, OWLView software allows users to display LIVE mode on the software trace screen. This enables users to view real-time trace updates on the large PC monitor in order to better see events that may not be visible on the OTDR LCD display.

To enable LIVE mode in OWLView software:

- 1) Launch OWLView software;
- 2) Click "Start Live Mode"
- 3) If the OTDR is not already in LIVE mode, follow the instructions that appear on the software screen, wait for LIVE mode on the OTDR to begin, then click "Start Live Mode" again.

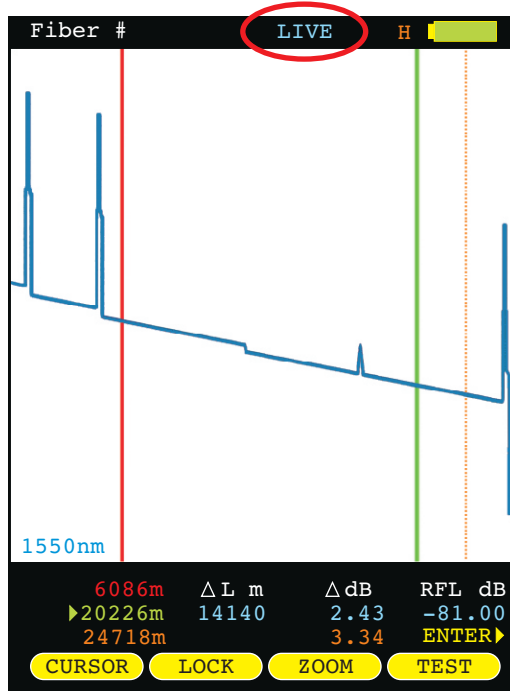
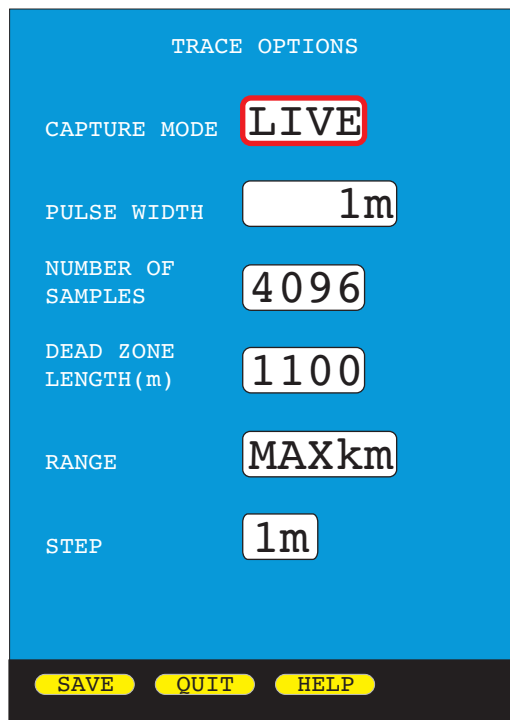

When LIVE testing is complete, press  again to exit LIVE mode.

SECTION 6: OPERATION/MAINTENANCE

CLEANING THE OTDR PORT

This cleaning procedure applies to the OTDR port on the OWLTrek II OTDR.

Required Accessories:

- > Isopropyl alcohol (91% or better)
- > In-adapter fiber optic cleaning accessories, such as 2.5mm cleaning swabs or 2.5mm HUXCleaner™
- > In-adapter fiber optic inspection scope (LCD-based, 200x magnification or greater recommended)
- > Compressed Air (optional)

Below are procedures for “wet” cleaning and “dry” cleaning. For best results, a combination of these cleaning methods is recommended.



IMPORTANT SAFETY NOTE: WHEN INSPECTING AN OPTICAL PORT, NEVER LOOK DIRECTLY OR INDIRECTLY INTO THE PORT WITHOUT SUFFICIENT EYE PROTECTION. THE OPTICAL PORT MAY BE ENERGIZED WITH POWERFUL INVISIBLE RADIATION THAT IS HARMFUL TO THE HUMAN EYE.

INVISIBLE LIGHT IS ESPECIALLY DANGEROUS SINCE THE EYE IS NOT AWARE OF EXPOSURE TO HARMFUL INVISIBLE ENERGY, AND BECOMES INCREASINGLY DANGEROUS WITH PROLONGED EXPOSURE.

TO AVOID ACCIDENTAL EXPOSURE TO OPTICAL ENERGY, IT IS HIGHLY RECOMMENDED TO POWER OFF EQUIPMENT BEFORE INSPECTING OPTICAL PORTS.

IT IS ALSO HIGHLY RECOMMENDED TO USE AN LCD-BASED FIBER INSPECTION SCOPE, WHICH CAN INSPECT OPTICAL PORTS AND FIBER ENDFACES WITHOUT EXPOSING THE EYE TO HARMFUL OPTICAL RADIATION.

“WET” CLEAN PROCEDURE

- 1 Wet the tip of a 2.5mm cleaning swab with isopropyl alcohol.
- 2 Carefully insert the wet tip of the swab into the optical port.
- 3 Clean out the optical port according to the directions provided with the swabs.
- 4 Blow dry the optical port with the compressed air. If compressed air is not available, allow 2 minutes for the alcohol to evaporate.
- 5 Inspect the optical port with the in-adapter fiber optic inspection scope to ensure the port is clear of obstructions.

“DRY” CLEAN PROCEDURE

- 1 Carefully insert a dry 2.5mm cleaning swab or a 2.5mm HUXCleaner™ into the optical port.
 - 2 Clean out the optical port according to the directions that came with the cleaning accessories.
 - 3 Inspect the optical port with the in-adapter fiber optic inspection scope to ensure the port is clear of obstructions.
- If the port is still dirty, another round of cleaning will be necessary. You may also want to use a combination of “wet” and “dry” cleaning to achieve best results.

If the port is still dirty, another round of cleaning will be necessary. You may also want to use a combination of “wet” and “dry” cleaning to achieve best results.

SECTION 7: OWLVIEW FOR OTDR SOFTWARE

OVERVIEW

OWLView for OTDR is a software program that is included free of charge with every OWLTrek II OTDR.

Primary functions of this software include:

- Downloading stored traces from OWLTrek II OTDRs and saving traces in native .OTD format
- View and analyze traces
- Export stored traces to SOR format (version 2)
- Import SOR files (that were previously exported with OWLView)
- Print stored traces
- View traces in real-time while OTDR is set into Live Mode
- Update firmware in OWLTrek II OTDRs
- View helpful PDF and video documentation

INSTALLING OWLVIEW FOR OTDR SOFTWARE

OWLView for OTDR can be installed onto a Windows™ PC or laptop from the supplied USB flash drive, or can be downloaded from OWL's website. This installation will also install the appropriate USB driver.

INSTALLING FROM USB FLASH DRIVE

- 1) Insert USB flash drive into a USB port on the PC or laptop (there may be a short delay while the computer installs the flash drive hardware and assigns a drive letter to the flash drive)

Depending upon computer configuration, the flash drive may or may not run the installation program automatically

– If the installation program runs automatically, skip to Step 5.

– If the installation program does not run automatically, continue to Step 2.

- 2) Using My Computer, browse to the drive letter created when the flash drive was inserted (drive letter may vary for different PC configurations)
- 3) Double-click the drive letter to view the contents of the USB flash drive
- 4) Double-click the LaunchCD installation program
- 5) Click "Install OTDR USB Driver/OWLView Software" button to begin the program installation.

Follow the on-screen instructions to complete the installation.

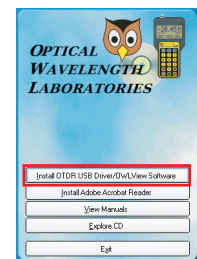
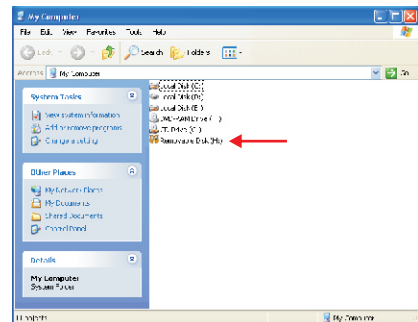

INSTALLING FROM WEBSITE

- 1) Browse to OWL's website at the following location:

<http://owl-inc.com/literature/sub/html/otdr/owlview.htm>

- 2) Click the "OWLView for OTDR Software" link to download the software.
- 3) Once the software is downloaded, double-click on the installation program.

Follow the on-screen instructions to complete the installation.

SECTION 7: OWLVIEW FOR OTDR SOFTWARE

LAUNCHING THE SOFTWARE

For Windows™ operating systems up to Windows 7:

Start ▶ Programs ▶ OWL ▶ OWLView for OTDR ▶  OWLView for OTDR

For Windows 8:

Click Start icon. If there is no OWLView for OTDR panel, access the Apps menu.

QUICK-LAUNCH PANEL

When OWLView software is launched, a quick-launch panel appears (as shown at right).

This panel contains three main sections:

- 1) traditional menu-based functions;
- 2) frequently-used Common Actions; and
- 3) recently opened trace files.

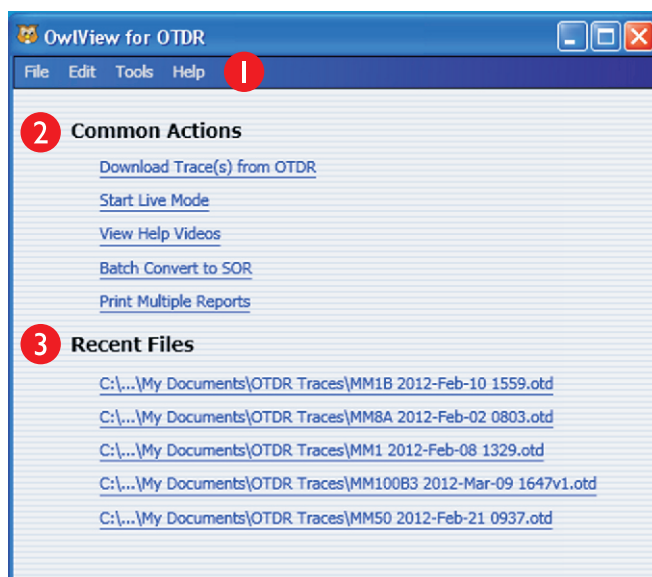

OPERATING THE SOFTWARE

DOWNLOADING TRACES FROM OTDR

- 1) Connect the OTDR to the PC using the supplied USB download cable.
NOTE: if prompted to install new hardware, follow the on-screen directions to complete the USB driver installation.

- 2) Trace download can be initiated two ways:
 - **Common Actions:** “Download Trace(s) from OTDR”
 - **File menu:** Download Traces...

- 3) The dialog box (similar to the one at right) will appear with a listing of the OTDR traces that have not yet been downloaded to a PC.

NOTE: to view all traces stored in the OTDR, check the box next to “Show previously downloaded traces”.

Select the traces to download by checking the box next to the traces.

To download all the displayed traces, check the “Select / Deselect All” box.

- 4) Once traces are selected, click **Download** to initiate the download process.

Stored traces will automatically be saved in “My Documents” in the “OTDR Traces” subfolder

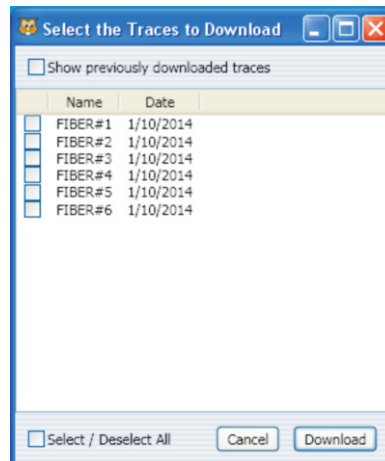

SECTION 7: OWLVIEW FOR OTDR SOFTWARE

OPERATING THE SOFTWARE, CONT.

OPENING A STORED TRACE

- 1) From the trace screen, click **File, Open...**
The dialog box will open up to the default directory. If the traces are stored elsewhere on the PC, browse to that directory.
 - 2) Highlight the trace name to be viewed and click "**Open**", or double-click on the trace name.
The selected trace will appear in the software screen.
- NOTE:** only one trace may be viewed at a time.

SAVING TRACES

There are two menu options for saving traces. Traces can only be saved from the trace screen:

- 1) **File, Save...** saves the trace with the same file name in the same location.
NOTE: the File, Save... option will be disabled ("grayed out") unless information has been added to Miscellaneous Info
- 2) **File, Save As...** allows the user to save the trace with a different file name and/or in a different location.

PRINTING TRACES

To print the currently viewed trace:

- 1) Click **File, Print...**
- 2) Select the printer from the "Print" dialog box
- 3) Click **Print**

NOTE: the printout will print exactly what is shown in the trace area; i.e. if the trace was zoomed in on, only the part of the trace that is zoomed in on will print. Clicking File, Print Preview will show a preview of the trace printout.

Consult the Zoom In/Out section in this manual for more information about viewing the complete trace in the trace area.

PRINTING MULTIPLE TRACES

NOTE: printing multiple traces must be activated from the Common Actions screen. Close all traces before attempting to print multiple trace reports.

- 1) From the "Common Actions" screen, click the **Print Multiple Reports** hyperlink
- 2) Browse to the folder where the trace files to be printed are located

NOTE: all the traces to be printed simultaneously with this function must be located in the same location.

- 3) Select all of the traces to be printed

NOTE: hold the SHIFT key to select/deselect a range of traces; hold the CTRL key to select/deselect traces one by one; or press CTRL+A to select all traces in the folder. When using CTRL+A, de-select any additional folders that may have been highlighted.

- 4) Click **Open** to begin the print job

NOTE: when printing a large number of traces at once, a warning screen may appear. It is recommended to limit print jobs to less than 240 traces at a time.

SECTION 7: OWLVIEW FOR OTDR SOFTWARE

OPERATING THE SOFTWARE, CONT.

CLOSING TRACES

To close the currently viewed trace:

- 1) Click **File, Close**

WORKING WITH SOR FILES

OWLView software can export native .OTD files into an industry-standard file format called SOR version 2. Non-OWL trace viewing software may be able to open these SOR files for trace comparison.

EXPORT SOR FILES

To export the currently viewed trace into SOR format:

- 1) Click **File, Export SOR file...**
- 2a) If the trace contains one wavelength, browse to the folder where the SOR file should be stored, rename the file if necessary, then click **Save**
- 2b) If the trace contains two wavelengths, a separate SOR file will be created for each wavelength.

A dialog box will appear allowing the user to choose a directory, as well as a different filename for the two different SOR files to be created.

Click **Export** to save the files.

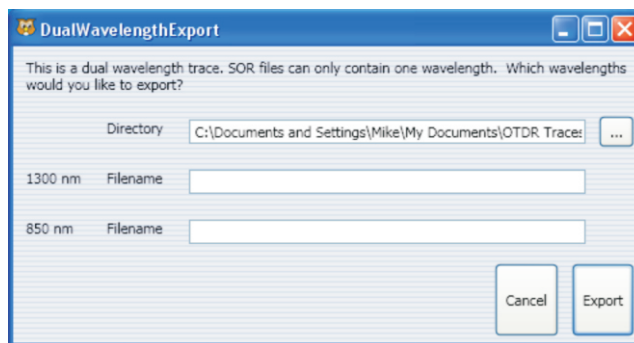

BATCH EXPORT SOR FILES

OWLView contains a function that allows a large number of .OTD files to be exported simultaneously. However, this function is limited to traces with one wavelength only. Dual-wavelength traces must be exported one at a time.

- 1) From Common Actions, click the **Batch Convert to SOR** hyperlink
- 2) Browse to the folder where the SOR files will be stored
- 3) Click **Open**

IMPORT SOR FILES





NOTE: only SOR files exported with OWLView software can be imported with this function.

- 1) Click **File, Import SOR File...**
- 2) Browse to the folder that contains the SOR file to be imported
- 3) Click **Open**

SECTION 7: OWLVIEW FOR OTDR SOFTWARE

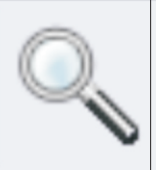
WORKING WITH TRACES

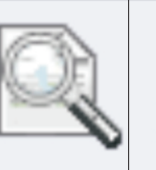
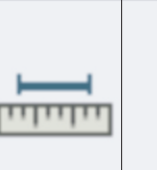
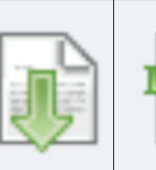
BUTTON CONTROLS

							
PAN Click and drag using the mouse will pan the trace screen up/down and left/right	RECTANGLE ZOOM Drag a rectangle on the trace screen to automatically zoom into the area viewed in the rectangle	ZOOM IN Click to zoom in on the trace screen in small increments	ZOOM OUT Click to zoom out on the trace screen in small increments	FIT TO SCREEN Resets the trace screen to full zoom out	SHOW/HIDE CURSORS Shows or hides the cursors used for trace analysis	DOWNLOAD TRACES Download traces from the OTDR	LIVE MODE View the OTDR trace in real-time as it changes on the OTDR itself (more on this function later in the manual)

THUMBNAIL VIEW

Shows a small thumbnail of the overall OTDR trace

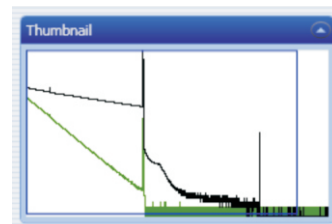

TRACE DETAILS

Contains information about the trace parameters used for the OTDR trace:

Name	Name of trace entered when trace was stored
Wavelength ($\lambda 1$)	First test wavelength
Wavelength ($\lambda 2$)	Second test wavelength (if applicable)
Index of Refraction ($\lambda 1$)	Index of refraction for first wavelength
Index of Refraction ($\lambda 2$)	Index of refraction for second wavelength (if applicable)
Pulse Width	Shown in nanoseconds (pulse width in OTDR is shown in meters; conversion factor is 10ns per meter)
Number of Averages	Sampling rate
Fiber type	Type of fiber tested
Date of Test	Date that the fiber was tested
Trace Length	Shows the total trace length, including the noise area of the trace

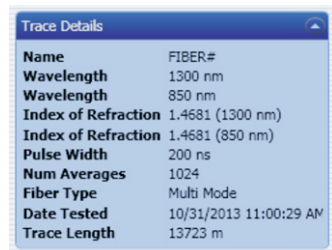

SECTION 7: OWLVIEW FOR OTDR SOFTWARE

WORKING WITH TRACES, CONT.

TRACE SCREEN

Shows the following information:

OTDR trace(s). Each wavelength is assigned a different color

Wavelength legend. Indicates the color of each wavelength trace.

Events. Corresponds to the event numbers in the event table.

Distance. Shown in either meters or feet on the X axis.

Power level. Shown in dB on the Y axis; 0 dB (a.k.a. origin) can be set to either top or bottom of Y axis.

Cursors. When cursors are activated, they will appear on the trace screen as red and green vertical lines.

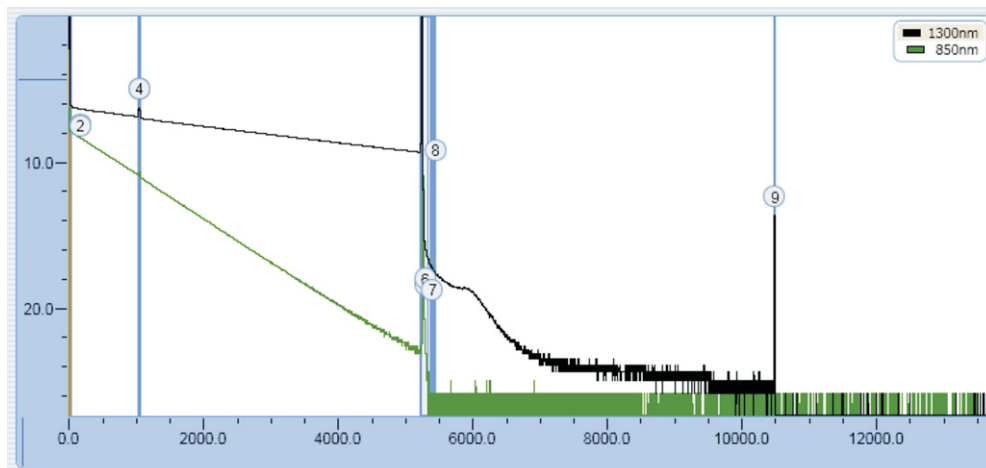

EVENT TABLE

Shows the following information:

Event #. Shows the event number; corresponds to the event number shown on the trace screen.

#	Event Type	Event Start	Event End	Reflectivity (1300 nm)	Loss (1300 nm)	Reflectivity (850 nm)	Loss (850 nm)
1	Reflective Start	0 m	37 m	-50.46 dB			
2	Reflective	0 m	41 m			-57.58 dB	
3	Reflective	1043 m	1074 m	-57.80 dB	0.08 dB		
4	Reflective	1049 m	1079 m			-67.31 dB	0.09 dB
5	Reflective	5239 m	5386 m	-34.41 dB	7.70 dB		

Event Type. Shows the type of event: reflective, non-reflective, reflective start, reflective end, multiple reflective, etc.

Event Start. Shows the distance to the start of the event (in either meters or feet).

Event End. Shows the distance to the end of the event (in either meters or feet).

Reflectivity. Also called reflectance; indicates how much light reflects back towards the OTDR (applies to reflective events only).

Loss. Also called attenuation; indicates how much loss occurs through the event.

MISCELLANEOUS INFO

Allows users to enter custom information about the trace.

Miscellaneous Info	
Cable ID	<input type="text"/>
Client Info	<input type="text"/>
Company	<input type="text"/>
Location	<input type="text"/>
Phone	<input type="text"/>
Tested By	<input type="text"/>
Company	<input type="text"/>
Email	<input type="text"/>

STATUS BAR

Shows current distance and dB at the mouse cursor position.

Cursor Position -2170.19 m 4.02 dB

SECTION 7: OWLVIEW FOR OTDR SOFTWARE

WORKING WITH TRACES, CONT.

RECTANGLE ZOOM

The rectangle zoom feature allows the user to drag a rectangle on the OTDR trace to quickly zoom in on the portion of the trace highlighted by the rectangle. Figure 1 below shows an example of rectangle zoom.



The highlighted rectangle in Figure 1 is a click-and-drag operation. Once the mouse button is released, the trace area changes to show the area of the trace produced by the rectangle (see Figure 2 below).

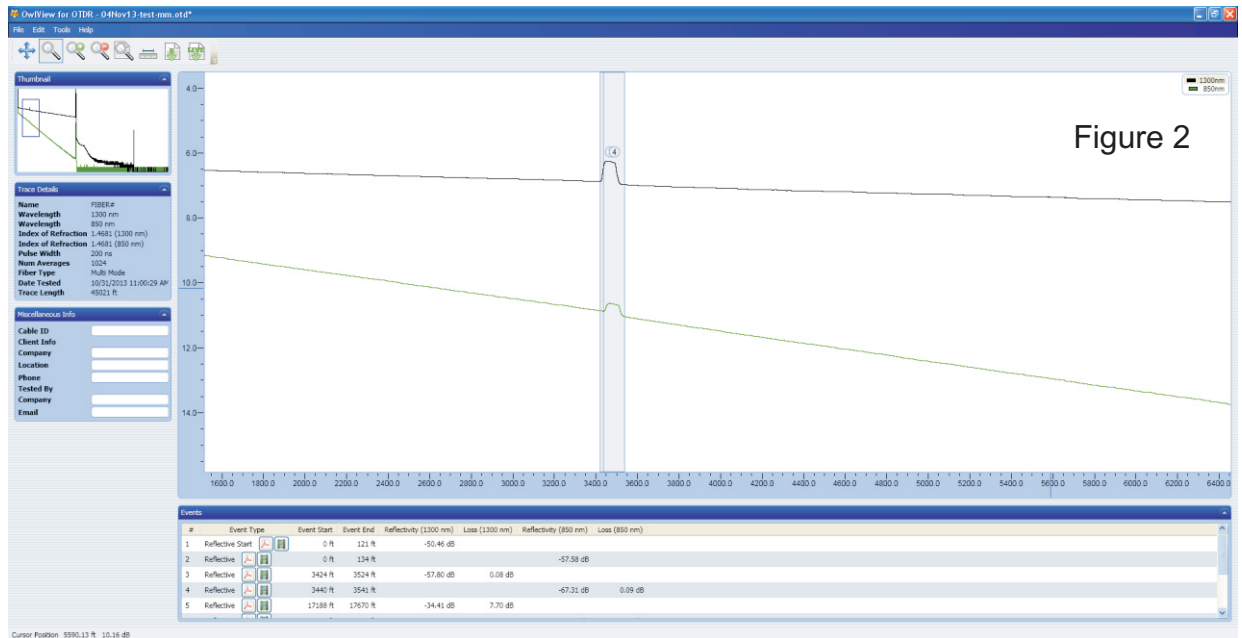

SECTION 7: OWLVIEW FOR OTDR SOFTWARE

WORKING WITH TRACES, CONT.

ZOOM IN/OUT

Clicking on the ZOOM IN and ZOOM OUT buttons zoom in and out on the trace at small increments.

SHOW/HIDE CURSORS

Clicking on the SHOW/HIDE CURSOR button either shows or hides the two cursors used for event analysis.

The cursors may be moved manually by click-and-drag.

EVENT ANALYSIS / PROPER CURSOR PLACEMENT

See pages 11-13 for more information about event analysis and proper cursor placement.

TOOLS MENU

UPDATE FIRMWARE

The firmware of the OWLTrek II OTDR may be updated at the user's location by clicking **Tools, Update Firmware ▶**.

NOTE: see page 19 in this manual for information about how to check your OTDR's current firmware version.

- 1) Click **Check for Updates...** (requires internet access) to download the firmware file from the OWLTrek II OTDR firmware update webpage onto the user's PC.
- 2) Connect the OWLTrek II OTDR to the PC via the USB download cable.
- 3) Click **From File...** then browse to the location where the firmware update file was saved to the user's PC.
- 4) Click **Open** to begin the firmware update

CHANGE LENGTH UNITS

Click **Tools, Meters** to view the length measurements in meters.

Click **Tools, Feet** to view the length measurements in footage.

The cursors may be moved manually by click-and-drag.

INVERT Y AXIS

Click **Tools, Inverted Y Axis** to set the origin of the Y axis to either the top or the bottom.

HELP MENU

The Help menu contains links to helpful videos and PDF files, as well as information about OWLView for OTDR software.

SECTION 8: APPENDICES

SPECIFICATIONS

Optical Specifications				
	WTO2-M83		WTO2-S35	
Fiber Type:	Multimode		Singlemode	
Output Wavelength:	850 nm	1300 nm	1310 nm	1550 nm
Dynamic Range (SNR=1) ² :	27 dB	29 dB	28 dB	27 dB
Distance Range ⁵ :	12 miles (20 kilometers)		80 miles (128 kilometers)	
Event Dead Zone ³ :	2 meters (typical)			
Attenuation Dead Zone ⁴ :	7 meters (typical)			
Maximum Data Points:	64000			
Data Point Spacing:	1 meter		Up to 64 km: 1 meter / Over 64 km: 2 meters	
Pulse Width:	1, 2, 5, 10, 20, 50, 100 meters		1, 2, 5, 10, 20, 50, 100, 200, 500, 1000 meters	
Index of Refraction:	1.4000 to 1.6000			
Distance Accuracy:	Up to 64km: 1 + (distance in meters/10000) / Over 64km: 2 + (distance in meters/10000)			
Number of Stored Traces:	Maximum trace distance: up to 200 / Minimum trace distance: 3000+			

1: All price shown are in US Dollars (USD). List price is shown for US customers only. Prices outside the US may vary based on individual countries' import duties and taxes, currency conversion, and other value added charges.

2: Using maximum pulse width

3: Width measured 1.5dB down on each side of a reflective event using 1 meter pulse width

4: Distance from event beginning to within 0.5dB where backscatter resumes using 1 meter pulse width

5: Out to furthest reflective event

General Specifications	
Display Type:	High-resolution Color LCD
Display Size:	2.8" diagonal
Battery Type:	Lithium Polymer
Battery Life:	up to 20 hours normal usage
Dimensions:	2.87" x 4.42" x 1.25"
Weight:	10 ounces (284 g)
Visual Fault Locator Specifications	
Output Wavelength:	650nm
Output Power:	1 mW
Operating Mode:	CW / Flash

MAINTENANCE INFORMATION

Repair. Repair of this unit by unauthorized personnel is prohibited, and will void any warranty associated with the unit.

Battery Replacement. The OWLTrek II contains an internal Lithium Polymer battery. If the battery requires service, the device must be sent in to OWL. Unauthorized attempts to service the battery will void the product warranty.

Cleaning. For accurate readings, the optical connector port on the OWLTrek II and the connector on the patch cable should be cleaned prior to attaching them to each other. Minimize dust and dirt buildup by replacing the dust caps after each use.

Warranty. The OWLTrek II comes standard with a two-year factory warranty, which covers manufacturer defect and workmanship

CONTACT INFORMATION

Address:

Optical Wavelength Laboratories, Inc.
N9623 US Hwy 12
Whitewater, WI 53190

Internet:

OWL-INC.COM

Phone:

262-473-0643