

# Optical Wavelength Laboratories

## OPERATIONS GUIDE

### OWLTrek Optical Time Domain Reflectometer (OTDR)

Singlemode: WTO-S15 / WTO-S13 / WTO-S35  
Multimode: WTO-M85 / WTO-M13 / WTO-M83



Revision 1P

**OWL-INC.COM**

Optical Wavelength Laboratories (OWL)  
N9623 West US Hwy 12  
Whitewater, WI 53190  
Phone: 262-473-0643  
Internet: OWL-INC.COM

# SECTION I: INTRODUCTION

## TABLE OF CONTENTS

### SECTION I: INTRODUCTION

Before You Begin . . . . .	1
About This Manual . . . . .	1
Description . . . . .	2
Performance Expectations and Limitations . . . . .	2
Reflective Events . . . . .	2
Fault Location . . . . .	2
Fiber Length Measurement . . . . .	2
Backscatter Events . . . . .	2
Backscatter Events . . . . .	2
Attenuation Measurement . . . . .	2
Precautions . . . . .	3
Eye Safety . . . . .	3
Electrical Safety . . . . .	3
Operational . . . . .	3
Connector . . . . .	3
Service . . . . .	3
Product Label . . . . .	3
Ports . . . . .	4
Buttons . . . . .	4
Display . . . . .	5
Indicator LEDs . . . . .	5

### SECTION 2: OTDR TESTING

Power ON/OFF . . . . .	6
Key OTDR Trace Parameters . . . . .	6
Wavelength . . . . .	6
Index of Refraction . . . . .	6
Capture Mode . . . . .	6
Pulse Width . . . . .	6
Number of Samples . . . . .	6
Dead Zone Length (m) . . . . .	6
Range . . . . .	6
Step . . . . .	6
Setting Test Parameters . . . . .	7
Set Wavelength . . . . .	7
Set Index of Refraction . . . . .	7
Setting Trace Options . . . . .	8
Capture Mode . . . . .	8
Pulse Width . . . . .	8
Number of Samples . . . . .	8
Dead Zone Length (m) . . . . .	8
Range . . . . .	8
Step . . . . .	8
Starting an OTDR Trace . . . . .	9
Cursor Navigation . . . . .	9

### SECTION 3: TRACE ANALYSIS

Overview . . . . .	10
Events . . . . .	10
Fiber Length Measurement/Link Loss . . . . .	11
Fiber Attenuation Measurement . . . . .	11
Reflectance Measurement . . . . .	12
Trace Events Menu . . . . .	12

# SECTION I: INTRODUCTION

## TABLE OF CONTENTS

<b>SECTION 4: TRACE STORAGE</b>	
Stored Readings/Setup Menu . . . . .	13
Saving a Trace . . . . .	13
Loading a Previously Stored Trace . . . . .	14
<b>SECTION 5: OTDR SETUP</b>	
Menus . . . . .	15
Navigating the Menu System . . . . .	15
Setup Menu . . . . .	15
Help Topics . . . . .	15
Operational Menu . . . . .	16
Set Backscatter Coefficient. . . . .	16
Trace Options . . . . .	16
Set Length Units. . . . .	17
System Information . . . . .	17
User Information Menu . . . . .	18
Enter User Name . . . . .	18
Enter Phone Number . . . . .	18
Display Preferences . . . . .	19
Mode . . . . .	19
Dimness . . . . .	19
Brightness . . . . .	19
Speaker . . . . .	19
Trace Clipping. . . . .	19
Power Options . . . . .	20
Dim Time . . . . .	20
Standby Time . . . . .	20
Off Time . . . . .	20
Utilities Menu . . . . .	21
Set System Clock . . . . .	21
Set APD Bias . . . . .	21
Format Data Flash. . . . .	21
Manufacturer Setup . . . . .	22
Factory Reset . . . . .	22
<b>SECTION 6: OPERATION/MAINTENANCE</b>	
Cleaning the OTDR Port . . . . .	23
<b>SECTION 7: APPENDICES</b>	
Specifications . . . . .	24
Maintenance Information . . . . .	24
Repair . . . . .	24
Battery Replacement . . . . .	24
Cleaning . . . . .	24
Warranty . . . . .	24
Contact Information . . . . .	24

# SECTION I: INTRODUCTION

## BEFORE YOU BEGIN

All personnel testing optical fibers should be adequately trained in the field of fiber optics before using any fiber optic test equipment. If the user is not completely familiar with testing fiber optics, they should seek competent training. Such training can be acquired from a variety of sources, such as local hands-on training classes or online courses.

This is especially true for Optical Time Domain Reflectometers (OTDRs). OTDRs are complicated technical devices, requiring a great amount of technical skill, knowledge, and expertise to operate. Proper setup and trace interpretation are paramount to a successful OTDR test, and the consequences of being inadequately trained could result in a significant amount of network down-time and repair costs.

In addition, OTDRs are delicate scientific instruments, and should be treated as such. Great care should be taken to ensure that all optical ports are kept clean and free from debris. The reasons for this are two-fold: 1) a clean OTDR produces accurate and precise results; and 2) if debris is allowed to build up in the OTDR test port, over time connector insertions will grind the debris into the OTDR port endface, resulting in scratches or “pits” that require extensive and costly repairs.

Valuable information about fiber optic testing can also be gathered from reading printed literature carefully or by thoroughly reading supplied operations manuals.

The main reason to use an OTDR is to locate faults in an optical fiber that exhibits unacceptable amounts of optical loss, or is no longer functioning properly. These faults are commonly called “events” and include anomalies such as breaks, shatters, connector endfaces, patch panels, splices, macro-bends, and micro-bends. By knowing the precise distance to an event, the technician can determine the nature of the event and quickly restore the network to its former working state.

There are two types of events detectable by an OTDR: Fresnel (reflective) and backscatter (non-reflective).

Fresnel events are caused by “glass-to-air” boundaries in the optical fiber, which causes a high amount of light to be reflected directly back toward the OTDR. Common Fresnel events include breaks, shatters, connector endfaces, patch panels, or even the end of the fiber. End-of-fiber detection can also be used to measure the end-to-end length of the fiber.

Backscatter events are caused by the intrinsic properties of the optical fiber. The make-up of the optical fiber scatters the light in all directions, including a small amount that gets scattered back towards the OTDR. Common backscatter events are splices, (either fusion or mechanical), macro-bends, and micro-bends. Backscatter can also be used to measure the attenuation (loss) on a certain section of an optical fiber.

## ABOUT THIS MANUAL

Throughout this manual you will find various symbols that assist with understanding the procedures outlined in this manual. Below is a list of these symbols and a short description of their purpose:



Helpful tip



Cautionary information



Potentially dangerous condition or operation

# SECTION I: INTRODUCTION

## DESCRIPTION

Upholding OWL's commitment to high-quality, yet affordable, fiber optic test equipment, the OWLTrek OTDR from OWL enables fiber optic professionals to quickly and easily troubleshoot and locate optical faults in singlemode fibers.

The OWLTrek is truly a hand-held unit, being one of the smallest OTDRs on the market today – easily able to fit into a shirt pocket – yet having capabilities of other OTDRs costing thousands of dollars more.

Optical fiber traces are displayed on a high-resolution color LCD display which implements state-of-the-art display technology to allow the OTDR's high-resolution color LCD display to "flip" between portrait or landscape mode automatically simply by rotating the device 90°. By "flipping" from portrait to landscape, the user sees a wider viewing area, displaying more trace information on the high-resolution color LCD, and allowing for greater viewing detail.

Important OTDR trace parameters such as pulse width, index of refraction, and data point averaging are fully user-configurable, and are accessible through an intuitive menu system. A minimum of 65 traces using the longest trace distance can be stored in the OWLTrek's internal memory.

Powering the OWLTrek is a re-chargeable Lithium-polymer battery that allows for up to 20 hours of normal usage.

The OWLTrek is equally suited to testing singlemode fibers in many test environments, including LAN, MAN, WAN, FTTH, Telco, CATV, Manufacturing, and Laboratory.

## PERFORMANCE EXPECTATIONS AND LIMITATIONS

### REFLECTIVE EVENTS

**Fault Location.** The main function of the OWLTrek OTDR is to detect the presence of highly reflective events, otherwise known as Fresnel events, such as breaks, shatters, patch panels, or the end of the fiber link. The distance to an event is shown as a spike on the OTDR trace, allowing the technician to quickly locate the problem and restore the network.

**Fiber Length Measurement.** The OWLTrek can give the operator a general idea of the length of the optical fiber by placing the cursors at the first and last reflective events, although the last reflective event is not guaranteed to be the end of the fiber. For example, a severe enough break mid-span could prevent the OTDR from detecting other events beyond the break, or the OTDR trace could show echoes or ghosts of previous Fresnel events.

### BACKSCATTER EVENTS

**Backscatter Events.** The OWLTrek has some ability to locate and measure backscatter events. Tweaking pulse-width and averaging settings may enhance the OWLTrek's ability to detect backscatter events. However, even with optimal settings, low loss backscatter events will become less detectable as the event gets farther away from the beginning of the fiber, especially on longer fibers.

Backscatter events are also more difficult to measure and interpret. Proper cursor placement is vital to the accurate measurement of backscatter events. Only individuals with OTDR training and expertise should attempt backscatter event measurement. Interpreting OTDR traces will be covered in more detail later in this manual.

**Attenuation Measurement.** Backscatter can be used to measure the attenuation (or loss) of certain sections of an optical fiber by placing the cursors at the beginning and end of the segment of fiber to be measured.

If available, however, a Power Meter / Light Source (PMLS) test kit or Optical Loss Test Set (OLTS) should always take precedence over an OTDR for end-to-end attenuation measurements.

# SECTION I: INTRODUCTION

## PRECAUTIONS

### Eye Safety



**NEVER** look into the connector port of any fiber optic test or transmission equipment, patch cable, fiber link, or other installed fiber. Always assume that active laser equipment is attached to optical fibers, and is powered on.



Do not run a test on the OTDR unless it is connected to the fiber under test, or the dustcap is firmly in place.

### Electrical Safety



Only use appropriate AC adapters for charging this device. Use of inappropriate power adapters could cause damage to the device, and could cause harm to the user from fire and electrical shock.

### Operational



Keep connector ferrules and optical connector ports clean to prevent irreparable damage to the OTDR port. For best results, replace dust caps after each use.

### Connector



For best results, do NOT insert APC (Angled Physical Contact) connectors into the OTDR port.

### Service



There are no user-serviceable parts in this device. Unauthorized attempts to service this product will void the product warranty.

## LABEL INFORMATION

On the back of each OWLTrek OTDR is a label similar to the one shown here containing model number, serial number, power requirements, and special cautionary information.

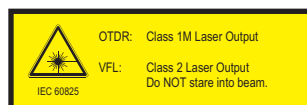

OTDR port Class 1M Laser Output

VFL port Class 2 Laser Output. Do NOT stare into beam.



USB port 6VDC, 1A

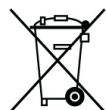

Directive 2002/96/EC of 27 January 2003 on waste electrical and electronic equipment (WEEE)

EU Directives EN 61326-1:2006 (EMC) and EN 61010-1:2001 (Safety)

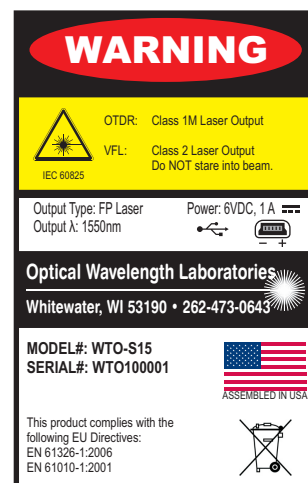

# SECTION I: INTRODUCTION

## PORTS

- 1 **Visual Fault Locator Port (VFL)** – Visual Fault Locator port for troubleshooting
- 2 **USB Download Port** (  ) – downloads data from the OTDR to the PC for software trace analysis and digital data storage; also used for battery charging
- 3 **OTDR Port (OTDR)** – connects the OTDR to the fiber under test
- 4 **Reset Button** – resets the OTDR in case of malfunction

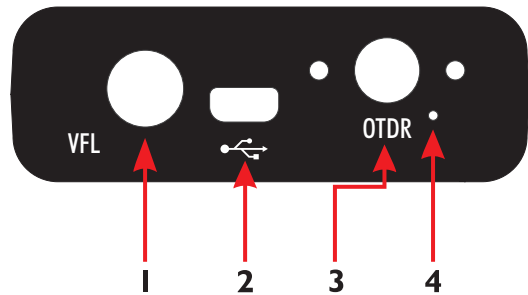

## BUTTONS

- 5 **Menu Buttons** – activates the associated menu option
- 6 **Navigation Buttons** – moves cursors or menu options in the direction of the button, or are used to zoom in or out on cursor placement
- 7 **Power Button** – powers the OTDR on; press and hold to power off; also, while the OTDR is on, brief press will activate other functions
- 8 **Enter Button** – from the trace screen, this button changes the function options menu at the bottom of the screen. Also activates menu options while in the menu system



# SECTION I: INTRODUCTION

## DISPLAY

- 9 Fiber ID – name of the currently loaded fiber trace
- 10 OTDR Test Mode – shows which test mode the OTDR is in – AUTO, USER, SEMI, or FILT
- 11 VFL Indicator – shows the current VFL mode: blank = OFF; red = ON continuous; pink = ON flashing
- 12 Zoom Indicator – displays “H” for horizontal zooming, and “V” for vertical zooming
- 13 Battery Life Indicator – displays the remaining battery life
- 14 Trace Viewing Area – displays the results of the OTDR trace(s), which users can zoom in on for more detailed trace analysis
- 15 Trace Wavelength – shows the wavelength(s) of the traces displayed in the trace viewing area. The active trace wavelength will be listed on the left.

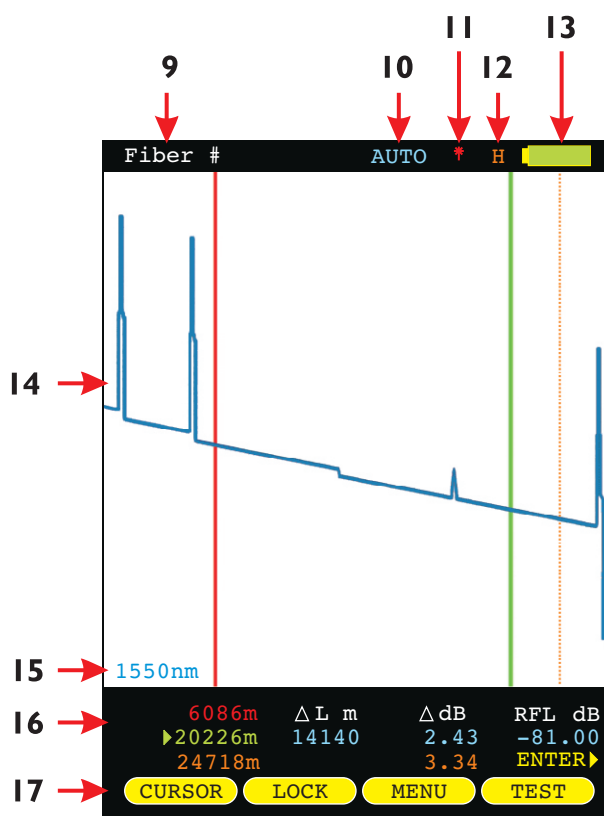

If more than one wavelength is present, the color of the trace corresponds with the color of the wavelength number

- 16 Trace Information – displays the relative position and power levels at and between the red and green cursors for the currently active trace.
- 17 Function Options Menu – displays the on-screen menu options for trace control

There are three sets of Function Options Menus. The Enter key (↵) is used to toggle between these three menus:



NOTE: the WAVE option will only be displayed if more than one wavelength is present



# SECTION I: INTRODUCTION

## INDICATOR LEDs

**18** **CHARGING STATUS** – will be lit when charging through a transformer or USB port

**GREEN** battery fully charged

**ORANGE** battery charging

**RED** problem with battery and/or charger; contact OWL for service

**19** **STANDBY STATUS**

Normal operation **GREEN** blinking

STANDBY **RED** solid; press any key to “wake up” the device

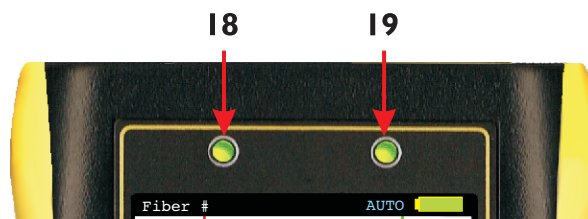

# SECTION 2: OTDR TESTING

## POWER ON/OFF

### POWER ON

Press  to power on the OTDR.

When the OTDR has completed startup, the trace area will either be blank, as shown at right, or will show the previously viewed trace.

Continue below for more information about running a new OTDR trace.

### POWER OFF

The OTDR may be powered off from any screen by holding .

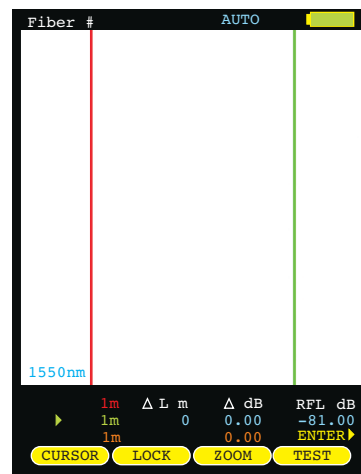

## KEY OTDR TRACE PARAMETERS

Below is a descriptive list of key OTDR trace parameters.

**WAVELENGTH – range of values: Multimode: 850, 1300, BOTH; Singlemode: 1310nm, 1550nm, BOTH.** Allows the user to select one or two wavelength(s) used for testing. Wavelength selection only applies to dual-wavelength OTDR.

**INDEX OF REFRACTION – range of values: 1.4000 to 1.6000.** To ensure the most accurate distance to events, Index of Refraction (IoR) should be set to the fiber manufacturer’s refractive index specification for the fiber under test. If unknown, set IoR to 1.4681 as this value falls within 99% of the IoR values for most optical fibers.

**CAPTURE MODE – range of values: AUTO, SEMI, USER, FILT, LIVE.**

- AUTO all trace options are determined automatically, except dead zone length.
- SEMI same as AUTO except the pulse width is not automatically determined.
- USER all user configured options are used when capturing the trace.
- FILT same as USER plus the software will filter (smooth) the trace to remove noise. This will help produce a cleaner trace with less averaging required.
- LIVE uses the user-defined trace settings to continuously update the trace on the screen. The trace will be updated after the user-defined number of averages is completed. The cursors and zoom functions work in LIVE mode. To start and exit LIVE mode, press the TEST function button.

**NOTE: if connected to a PC running OWLView software, LIVE mode also updates the software trace area**

**PULSE WIDTH – range of values: Multimode: 1, 2, 5, 10, 20, 50, 100 m; Singlemode: 1, 2, 5, 10, 20, 50, 100, 200, 500, 1000 m.** Pulse width offers a trade-off between the ability to measure longer cable distances (longer pulse width) versus the ability to see two events that are closely spaced (shorter pulse width). This is otherwise known as an OTDR’s event dead zone (i.e. the minimum distance between two events where they both can be measured).

**NUMBER OF SAMPLES – range of values: 256, 512, 1024, 2048, 4096.** Increasing the number of samples allows the OTDR to have better display resolution (events are easier to see, especially near the noise level), but also increase the trace acquisition time.

**DEAD ZONE LENGTH(m) – range of values: 0 to 1500.** Allows the user to enter the length of a dead-zone box (a.k.a. pulse suppressor), if one is being used. If a value is entered for dead zone, the dead zone portion of the OTDR trace will be grayed out. The active portion of the trace will begin where the dead zone ends.

**RANGE – range of values: 1, 2, 5, 10, 25, 50, 65, 128 km.** Allows the user to manually enter the total length of the trace. NOTE: for best results, this value should be set to the next highest value from the actual length of the fiber under test.

**STEP – range of values: 1, 2, 4 m.** Trace sample spacing. Smaller steps produce more accurate distance to events, but trace acquisition takes longer.

# SECTION 2: OTDR TESTING

## SETTING TEST PARAMETERS

### SET WAVELENGTH

When using a dual-wavelength OTDR, traces can be run at either one or two wavelengths.

To set the trace wavelength(s), press  from the trace screen until the following menu options appear:



allows the user to select one or both wavelengths to be used for testing. Arrow keys scroll through three options: 1310nm, 1550nm, BOTH. Press key again to exit.

The selected wavelength(s) will appear at the bottom of the trace screen. If two wavelengths are present on the trace screen, they will be displayed as either blue or brown.

The cursor information below the trace screen applies to the wavelength listed in blue.

 If the OTDR only has one wavelength installed, the WAVE option will not appear.

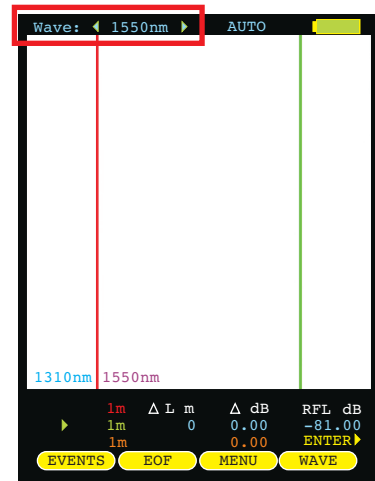

### SET INDEX OF REFRACTION

To set the index of refraction, press  from the trace screen until the following menu options appear:



allows the user to change the index of refraction; setting will appear at

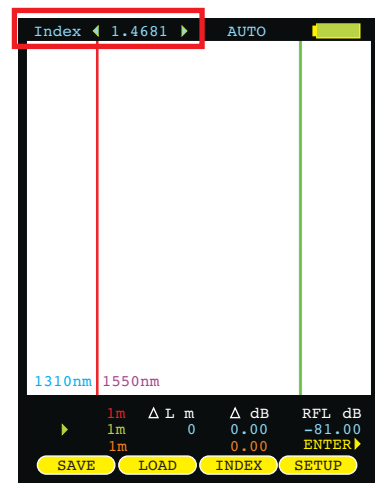

# SECTION 2: OTDR TESTING



## SETTING TEST PARAMETERS, cont.

### SETTING TRACE OPTIONS

To see an additional menu of trace options, press  from the trace screen until the following menu options appear:



 opens the TRACE OPTIONS menu

  selects the next or previous trace option

  changes the value in the selected trace option

#### CAPTURE MODE – Range of values: AUTO, SEMI, USER, FILT, LIVE

Capture Mode should be set to **AUTO** mode for a majority of testing scenarios, so the OTDR can automatically determine the best set of trace parameters based on the fiber link under test.

 **USER, SEMI, FILT, and LIVE** require the user to understand the consequences of setting trace parameters manually.

Only trained fiber optic professionals who are experienced with operating OTDRs should manually set trace parameters. Suggestions for setting these parameters are given below.

**PULSE WIDTH** – range of values: **Multimode: 1, 2, 5, 10, 20, 50, 100 m; Singlemode: 1, 2, 5, 10, 20, 50, 100, 200, 500, 1000 m.** Pulse width should be set to the shortest setting that allows multiple closely-spaced events to be clearly defined, while preventing any of the trace from reaching the noise floor.

**NUMBER OF SAMPLES** – Range of values: **256, 512, 1024, 2048, 4096.** Use the maximum number of samples unless traces are taking too long to acquire.

**DEAD ZONE LENGTH (m)** – Range of values: **0 to 1500.** Set this value to '0000' if not using a dead-zone box (a.k.a. pulse suppressor box). If using a dead-zone box, and you want to highlight the dead-zone box length on the trace, enter the length of the dead-zone box in meters.

**RANGE** – range of values: **1, 2, 5, 10, 25, 50, 65, 128 km.** Set to the next highest value from the actual length of the fiber under test. If fiber length is unknown, select MAX km.

**STEP** – Range of values: **1, 2, 4 m.** Use shortest STEP value for most accurate distance to events, unless trace acquisition time is too long.

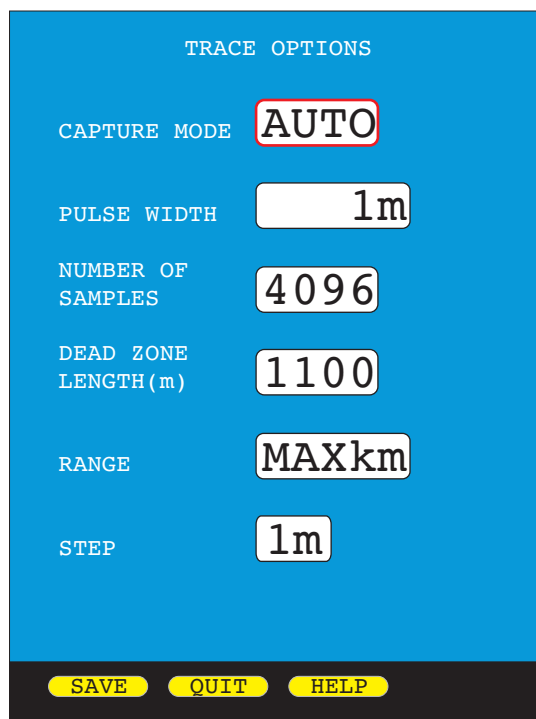

# SECTION 2: OTDR TESTING

## STARTING AN OTDR TRACE

Once the OTDR parameters have been set, an OTDR trace can be run. Press  from the trace screen until the following menu options appear:



 starts an OTDR trace based upon the current OTDR parameters

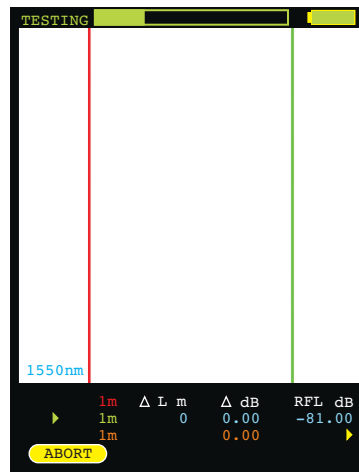

During the OTDR test (as shown at right):

- the ABORT soft-key appears (used to abort an OTDR trace)
- all soft-keys are disabled
- a bar graph appears at the top of the screen showing the progress of the OTDR test
- dual-wave test will run a separate trace automatically for each wavelength

## CURSOR NAVIGATION

Once the OTDR trace is complete, the OTDR trace will appear on the screen, and the OTDR information – distance and optical power – will be updated.

 two color coded traces will appear on the screen if a dual-wavelength trace was run

Trace information is color-coded. Red and green refer to the cursors. Blue text refers to the difference between the two cursors. Orange text refers to the perceived end of the fiber link.

 sets the active cursor – no cursor, red, green, or both red and green

 locks the active cursor at its current location; unlocks a locked cursor

When a cursor is locked, a colored padlock symbol will appear next to the appropriate cursor information

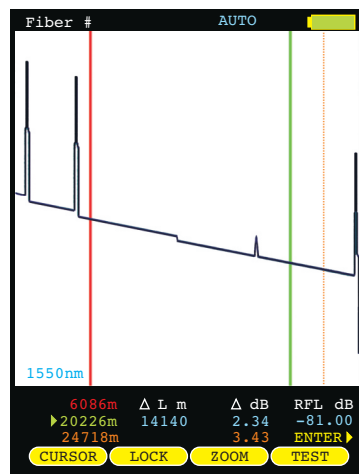

 sets the ZOOM mode to Horizontal (H) or Vertical (V)

 **WHEN ONE OR MORE CURSORS ARE SELECTED:** moves the cursor(s) left or right; holding these buttons speeds up the cursor movement

**WHEN NO CURSOR IS SELECTED:** screen pans left and right

 **WHEN ONE OR MORE CURSORS ARE SELECTED:** zooms in or out on the active cursor(s)

**WHEN NO CURSOR IS SELECTED:** zooms in and out on the center of the screen

# SECTION 3: TRACE ANALYSIS

## OVERVIEW

This section will provide a basic overview about how to analyze an OTDR trace, and will cover the different types of information that can be gathered from an OTDR trace, including:

- event location;
- fiber length measurement;
- fiber attenuation (loss); and
- reflectance measurement.

 proper interpretation of OTDR test results requires a significant amount of technical skill, knowledge, and expertise. Proper trace interpretation is paramount to a successful OTDR test, and the consequences of interpreting a trace incorrectly could result in a significant amount of network down-time and repair costs.

## EVENTS

The primary function of an OTDR is to locate events along the optical fiber. On an OTDR trace, events appear as deviations from an otherwise gently sloping line.

Below is a list of the different events shown in the example at right, including the type of event, and possible interpretations of the data:

- |          |             |   |
|----------|-------------|---|
| <b>1</b> | Fresnel     | end of dead-zone box (pulse suppressor)   |
| <b>2</b> | Fresnel     | patch panel using flat polish connectors  |
| <b>3</b> | Backscatter | fusion splice or macro-bend   |
| <b>4</b> | Fresnel     | patch panel using APC (angled physical contact) connectors  |
| <b>5</b> | Fresnel     | end of fiber link; could also indicate a severe break where no other events can be detected after the break |

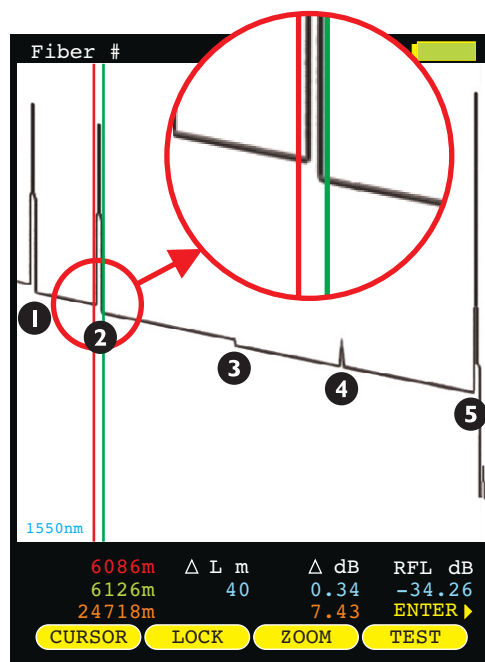

 If the slope of the trace appears to “dip” to a lower level after the event (events 1, 2, and 3), this could mean one of two things: 1) if the slope of the line changes, the refractive index of the fiber preceding the event is different from the refractive index of the fiber following the event, or 2) if the slope stays the same, then the event is simply a loss-inducing event.

 Tall spikes usually indicate flat polish connections or other highly reflective events (breaks, shatters, end of fiber, etc.), while short spikes usually indicate angled polish connections.

## CURSOR PLACEMENT

Proper cursor placement is critical in determining the exact distance to an event, as well as the relative effect the event has on optical power traveling through the event.

The **red** cursor should be placed right before the slope of the line begins to spike.

The **green** cursor should be placed after the event, at a point where the slope of the line returns to the normal backscatter level.

The trace information (located below the trace) will show the distance and relative power (in dB) at the point where each cursor is placed.

## SECTION 3: TRACE ANALYSIS

### FIBER LENGTH MEASUREMENT/LINK LOSS

By placing the cursors at the beginning and ending points of the fiber trace, the distance between the cursors will show a close approximation of the total length of the optical fiber link, as well as a close approximation of the total fiber link loss.

#### CURSOR PLACEMENT

Proper cursor placement is necessary to determine the end to end length and link loss of an optical fiber link. Refer to the diagram at right when placing cursors for fiber length measurement.

The **red** cursor should be placed directly before the first reflective event, before the slope of the line begins to spike.

The **green** cursor should be placed directly before the last event, before the slope of the line begins to spike.

The trace information (located below the trace) will show the distance and relative power (in dB) at the point where each cursor is placed, as well as the total link distance and end-to-end link loss.

In this example, the total link length is **24718 meters**, and the end-to-end link loss is **7.43 dB**.

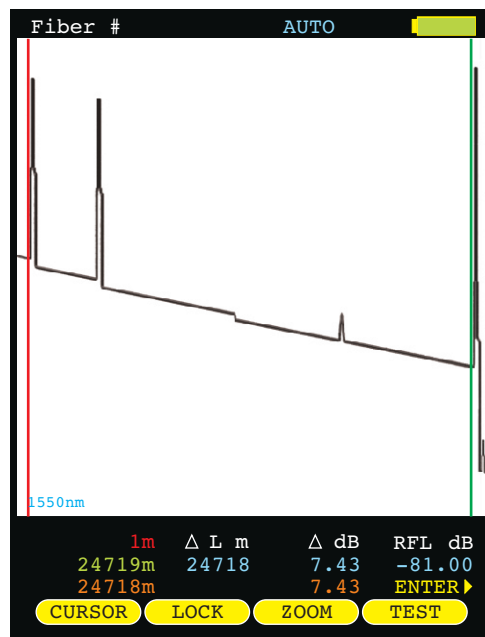

### FIBER ATTENUATION MEASUREMENT

The fiber attenuation, or loss, for a certain section of an optical fiber link can be determined by placing the cursors at the beginning and end points of the segment of fiber under test.

#### CURSOR PLACEMENT

Proper cursor placement is necessary to determine the attenuation of a certain segment of fiber.

The **red** cursor should be placed at the beginning of the section of fiber under test.

The **green** cursor should be placed at the end of the section of fiber under test.

The trace information (located below the trace) will show the distance and relative power (in dB) at the point where each cursor is placed, as well as the loss and distance of the section of fiber being analyzed.

In this example, the section of fiber being analyzed has **1.76 dB** of loss, and is **7040 meters**.

Using this information, dB per kilometer can also be calculated, which can be compared to the fiber manufacturer attenuation specification. To determine dB/km:

$$1.76 \text{ dB} / 7.040 \text{ km} = 0.25 \text{ dB/km}$$



In the example shown here, the attenuation measurement also includes the loss through the connector located near the red cursor.

# SECTION 3: TRACE ANALYSIS

## REFLECTANCE MEASUREMENT

The reflectance of a specific event can be determined by placing the cursors on either side of an event. The OTDR will show the reflectance in dB of the highest reflective event between the cursors.

## CURSOR PLACEMENT

Proper cursor placement is important when determining the reflectance of a reflective event.

The **red** cursor should be placed on the backscatter line directly before the event, on the sloping line before the spike.

The **green** cursor should be placed on the backscatter line somewhere after the event.

- Make sure that only one reflective event is included between the cursors.

The trace information (located below the trace) will show the reflectance (in dB) of the highest reflective event between the cursors.

In this example, the reflective event being measured has a reflectance of **-34.26 dB**.



## TRACE EVENTS MENU

Automatic event location can be performed from the trace screen by accessing the **EVENTS** function option. See page 5 for more information about function option menus.

- IMPORTANT NOTE: automatic event location is only meant to be used as a guideline for the location of possible events. It is ultimately up to the user to verify and determine if an event actually exists at that location.**

- LOCATION** the distance to the start of the event
- TYPE** type of event (reflective, loss, etc.)
- REFL** reflectance of the event
- LOSS** loss of the event

TRACE EVENTS			
Location	Type	Refl	Loss
14m	REFL	-47.38	0.87
24011m	LOSS	-81.00	0.21
50539m	REFL	-17.54	-11.63

- ▲ ▼** moves the cursor up and down in the list of detected events
- VIEW** returns the user to the trace screen, zoomed in on the selected event
- PAGE** displays the next page of events, if there are more events than will fit on the screen
- DONE** returns the user to the trace screen

Once an event has been selected from this menu, each individual event will be marked with a “tic” mark at the top of the trace area. The type of event is denoted by color: **black** for loss events and **light blue** for reflective events.



# SECTION 4: TRACE STORAGE

## STORED READINGS



sets the Function Options Menu to allow access to Data Storage and Setup Menu options. The following soft-keys apply to data storage functions.



SAVING A TRACE



LOADING A PREVIOUSLY STORED TRACE

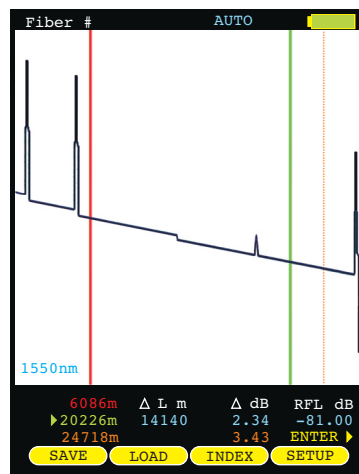

## SAVING A TRACE

Traces may be stored in permanent memory for later viewing or download to hard disk for data file retrieval.

From the trace screen, press **SAVE** to enter the fiber name and save the currently displayed trace to memory.

To enter a fiber name, use the arrow keys to highlight the appropriate character on the grid.



BACKSPACE



TOGGLE BETWEEN UPPER AND LOWER CASE ALPHABET



FORWARD SPACE



SELECT THE HIGHLIGHTED CHARACTER



FINISHED ENTERING NAME

Enter fiber name:

Fiber # █

A  B  C  D  E  F  G  H  I  J  K  L  M  
 N  O  P  Q  R  S  T  U  V  W  X  Y  Z  
 0  1  2  3  4  5  6  7  8  9  :  ;  <

Use arrows to highlight letter then press the enter key. Tap the power button to abort.

# SECTION 4: TRACE STORAGE

## LOADING A PREVIOUSLY STORED TRACE

Previously stored traces can be loaded from memory for later on-screen analysis.

The STORED TRACE menu may be accessed two ways:

- 1) from the Function Options menu on the trace screen, press  ; or
- 2) select the STORED TRACES option from the SETUP MENU.

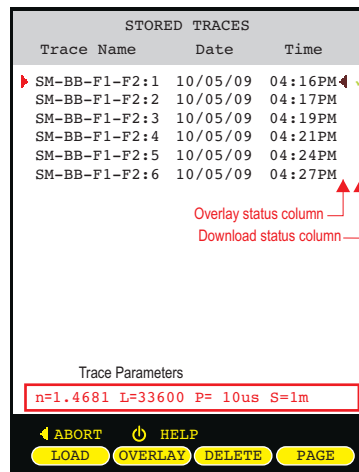

moves the cursor up and down in the list of stored traces



exits the STORED TRACES menu and returns to the trace screen



accesses context-sensitive help



loads the currently selected fiber trace into the trace screen



allows the user to overlay a previously stored trace on top of the currently loaded trace. Only one trace can be overlaid at a time, and the overlay trace is denoted by a dark arrow to the right of the trace information. Press this button again to clear the overlay status



gives the user the option: 1) to delete the currently selected fiber trace; 2) to not delete the selected trace; 3) to delete all traces; or 4) delete only traces that have been previously downloaded (see TRACE DOWNLOAD STATUS below)



displays the next page of fiber traces if there are more traces than will fit on the screen

**TRACE PARAMETER INFORMATION.** Information at the bottom of the STORED TRACES screen shows trace parameter settings used when the trace was taken:

- n** index of refraction
- L** fiber length
- P** pulse width
- S** step



**TRACE DOWNLOAD STATUS.** If the trace has already been downloaded to the PC, this trace will be marked by a green checkmark which appears at the right of each trace.

# SECTION 5: OTDR SETUP

## MENUS

To access the SETUP MENU, either press **MENU** or .

## NAVIGATING THE MENU SYSTEM

The arrow keys are used to navigate throughout the various menus and help screens in the OTDR. Green selection arrows highlight different menu options.



moves the selection arrows to the next or previous menu option



jumps to the highlighted menu option



returns to the previous menu



exits the menu system

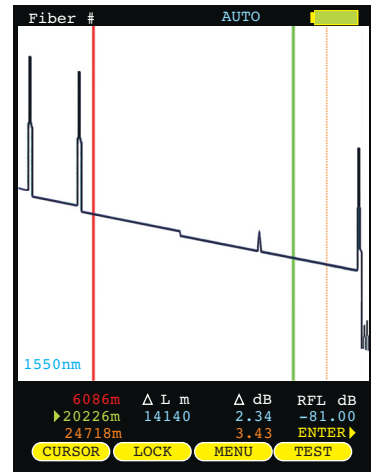

## SETUP MENU

The SETUP MENU is the main entry point into the OTDR menu system. Shown below is a tree of menu options.

Each option will be explained in detail on the following pages.

## HELP TOPICS

The OWLTrek includes a built-in help menu that can be accessed from the SETUP MENU. Context-sensitive help can also be accessed from various operational and menu screens throughout the OTDR.

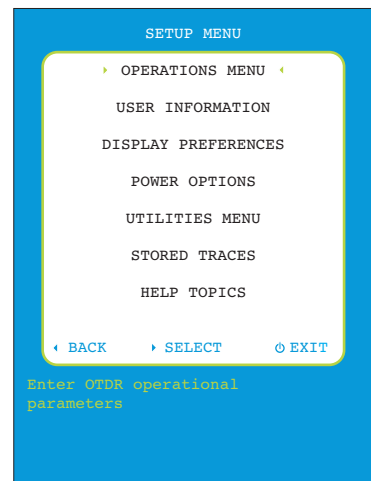

# SECTION 5: OTDR SETUP

## OPERATIONS MENU

OPERATIONS MENU

- TRACE PARAMETERS
- CONFIGURE OPTIONS
- SET BACKSCATTER COEFF.
- SET LENGTH UNITS
- SYSTEM INFORMATION

◀ BACK    ▶ SELECT    ◻ EXIT

Configure trace capture Parameters

## CONFIGURE OPTIONS

Enables the 2kHz tone and visual fault locator functions, if available.

CONFIGURE OPTIONS

FIBER ID TONE: N/A

VISUAL FAULT LOCATOR: N/A

Press ENTER when done  
Press ◻ for help

## SET BACKSCATTER COEFFICIENT

TRACE OPTIONS

CAPTURE MODE: USER

PULSE WIDTH: 10us

NUMBER OF SAMPLES: 4096

DEAD ZONE LENGTH (m): 1100

RANGE: MAXkm

STEP: 1m

SAVE    QUIT    HELP

Backscatter coefficient is a measure of the backscatter properties of the fiber under test, and is provided by the fiber manufacturer.

Backscatter coefficient is important in accurately determining reflectance measurements in the OTDR.

SET BACKSCATTER COEFFICIENT

Bns : -81.00

^ UP    v DOWN    ENTER=DONE

The fiber backscatter coefficient is a normalized measure of the backscatter properties of the fiber and is provided by the manufacturer.

## TRACE OPTIONS

See page 6 for more information on trace options.

# SECTION 5: OTDR SETUP

## OPERATIONS MENU

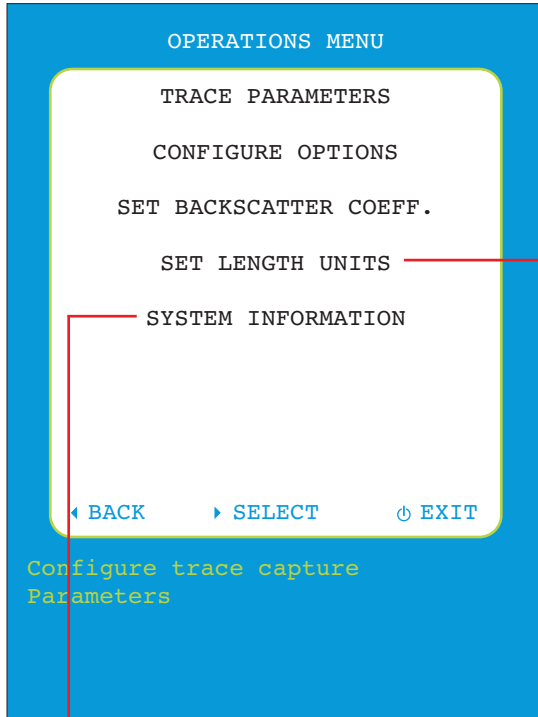

## SET LENGTH UNITS

Use left and right arrow buttons to toggle length units between meters and feet.

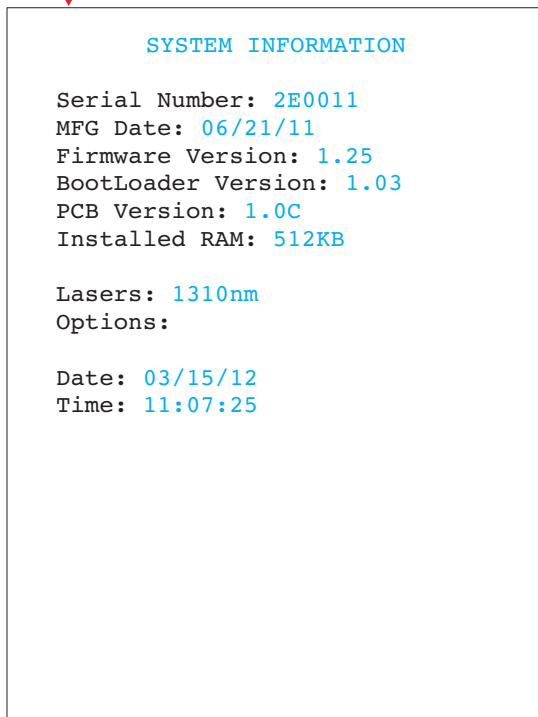
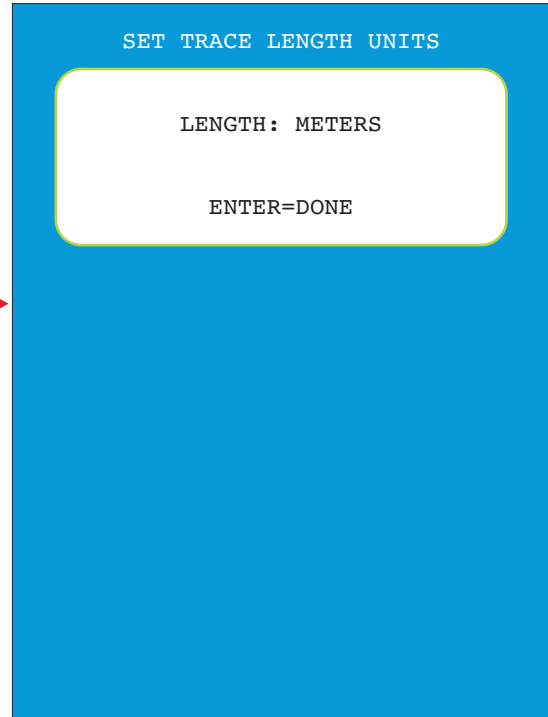

## SYSTEM INFORMATION

Shows key system information about the OTDR.

# SECTION 5: OTDR SETUP

## USER INFORMATION MENU

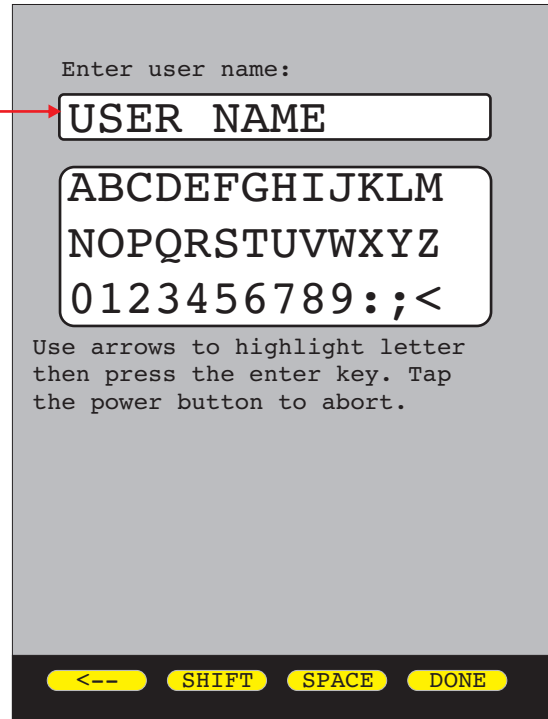
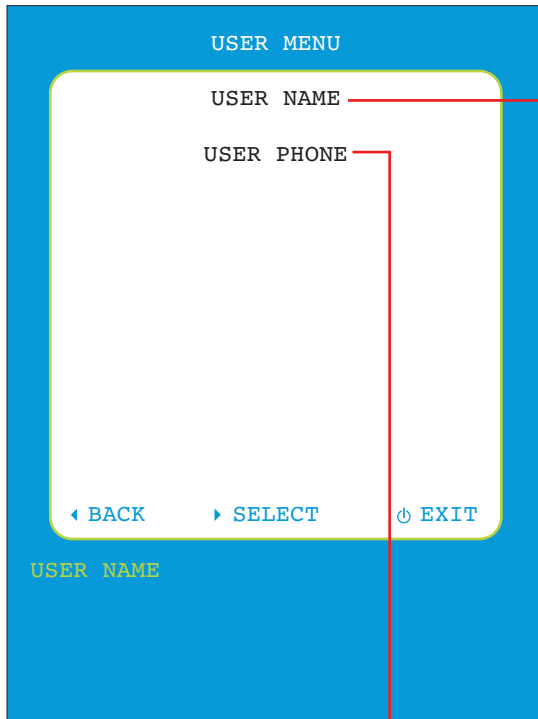

### Enter user name:

Enter the name of the person or company who owns the OTDR. This information will appear on test reports.

Up to 16 characters are allowed in the user name entry field.

See the on-screen instructions for help with text entry.

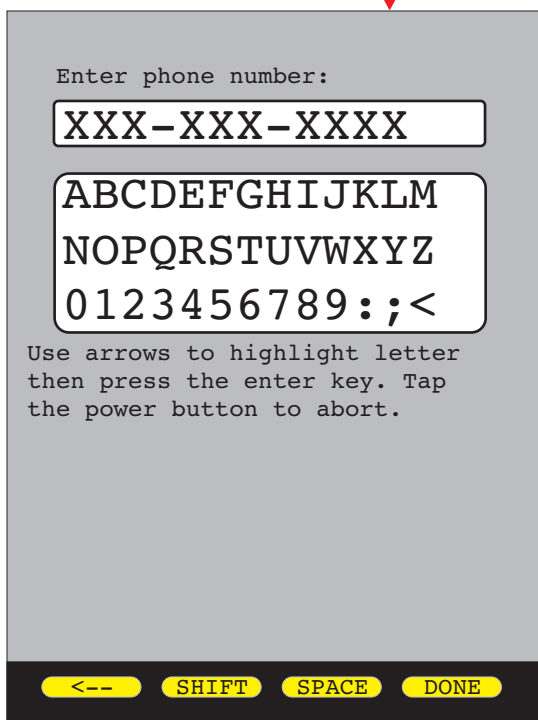

### Enter phone number:

Enter the phone number of the person or company who owns the OTDR. This information will appear on test reports.

Up to 13 characters are allowed in the phone number entry field.

See the on-screen instructions for help with text entry.

# SECTION 5: OTDR SETUP

## DISPLAY PREFERENCES

The screenshot shows a blue menu titled "DISPLAY OPTIONS" with the following settings:

- MODE: FLIP
- DIMNESS: 063
- BRIGHTNESS: 255
- SPEAKER: ON
- TRACE CLIPPING: ON

At the bottom of the menu are three yellow buttons: SAVE, QUIT, and HELP.

**MODE:**  
Sets the orientation of the LCD display. Three modes are available:  
FLIP LCD automatically alternates between portrait and landscape modes based upon the physical orientation of the OTDR  
PORTRAIT display is always in portrait mode  
LANDSCAPE display is always in landscape mode

**DIMNESS:**  
Sets the level of the LCD backlight during power saving mode. Range of values are 25 (dimmest) to 125 (brightest).  
NOTE: higher values require more battery power

**BRIGHTNESS:**  
Sets the level of the LCD backlight during normal operation. Range of values are 150 (dimmest) to 255 (brightest).  
NOTE: higher values require more battery power

**SPEAKER:**  
Toggles the internal speaker either ON or OFF.

### TRACE CLIPPING:

Toggles trace clipping mode either ON or OFF.

On a normal OTDR trace, as the sloping line of the trace approaches the noise floor of the OTDR, the trace starts becoming less smooth, making events harder to see near the end of the trace.

Trace clipping is a method that “clips” the top of the most reflective peaks, in order to draw the sloping line away from the noise floor. This effectively smooths out the trace, allowing smaller events to be more easily detectable.

While trace clipping is ON, reflectance measurements of clipped events are not affected.

# SECTION 5: OTDR SETUP

## POWER OPTIONS

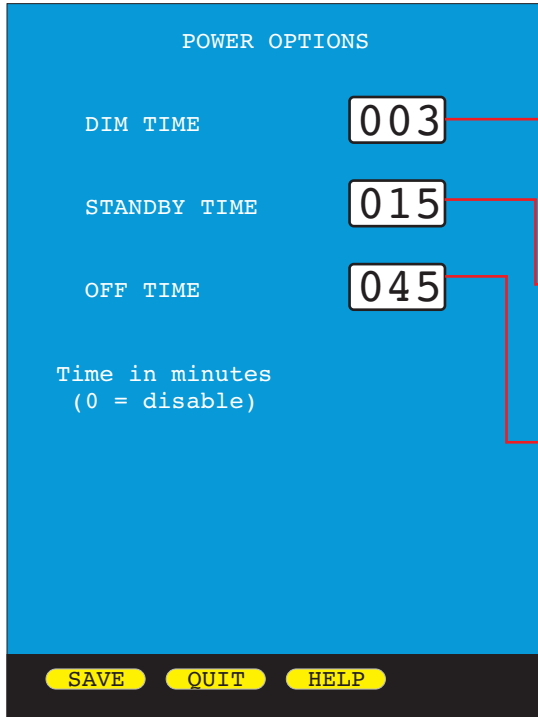

**DIM TIME:**

Sets the time (in minutes) before the display will enter DIM mode. Range of values is 1 to 250.

**STANDBY TIME:**

Sets the time (in minutes) before the OTDR will enter STANDBY mode. Range of values is 2 to 250.

**OFF TIME:**

Sets the time (in minutes) before the OTDR will power off. Range of values is 3 to 250.



# SECTION 5: OTDR SETUP

## UTILITIES MENU

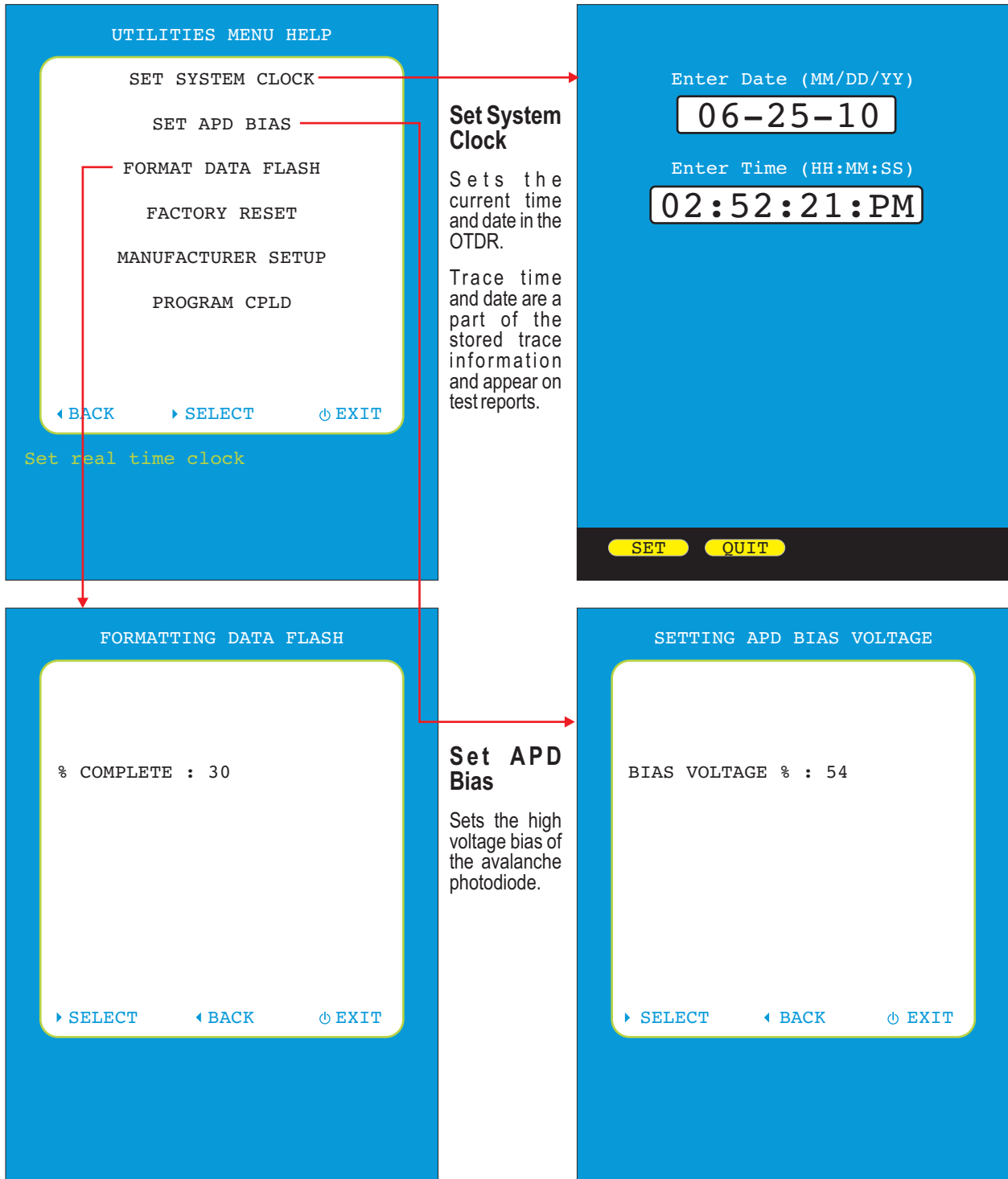

### Format Data Flash

Initializes the internal trace storage memory. This option will erase all stored traces, and should only be used in cases where the file system has become corrupted.

# SECTION 5: OTDR SETUP

## UTILITIES MENU, CONT.

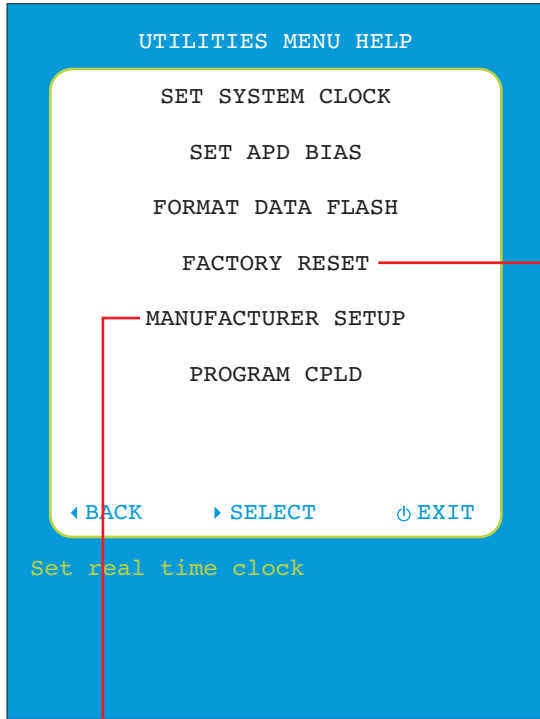

### Manufacturer Setup

Contains setup parameters accessible by the manufacturer only.

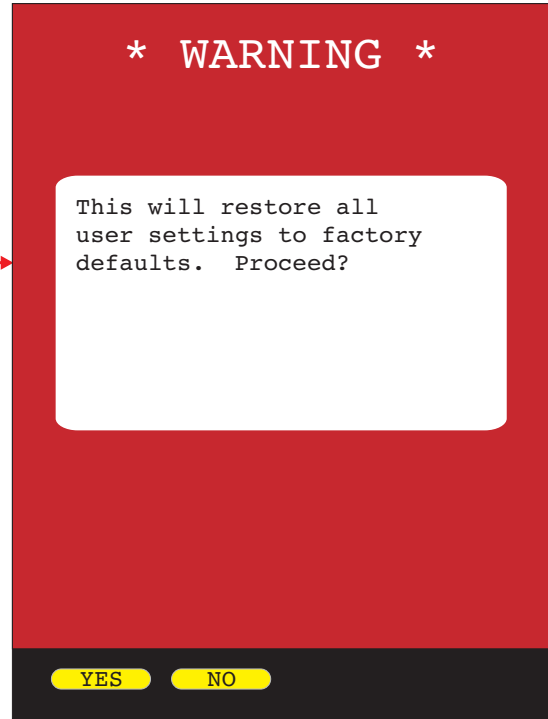

### Factory Reset

Restores user settings to factory defaults.

# SECTION 6: OPERATION/MAINTENANCE

## CLEANING THE OTDR PORT

This cleaning procedure applies to the OTDR port on the OWLTrek OTDR.

### Required Accessories:

- > Isopropyl alcohol (91% or better)
- > In-adapter fiber optic cleaning accessories, such as 2.5mm cleaning swabs or 2.5mm HUXCleaner™
- > In-adapter fiber optic inspection scope (LCD-based, 200x magnification or greater recommended)
- > Compressed Air (optional)

Below are procedures for “wet” cleaning and “dry” cleaning. For best results, a combination of these cleaning methods is recommended.



**IMPORTANT SAFETY NOTE: WHEN INSPECTING AN OPTICAL PORT, NEVER LOOK DIRECTLY OR INDIRECTLY INTO THE PORT WITHOUT SUFFICIENT EYE PROTECTION. THE OPTICAL PORT MAY BE ENERGIZED WITH POWERFUL INVISIBLE RADIATION THAT IS HARMFUL TO THE HUMAN EYE.**

**INVISIBLE LIGHT IS ESPECIALLY DANGEROUS SINCE THE EYE IS NOT AWARE OF EXPOSURE TO HARMFUL INVISIBLE ENERGY, AND BECOMES INCREASINGLY DANGEROUS WITH PROLONGED EXPOSURE.**

**TO AVOID ACCIDENTAL EXPOSURE TO OPTICAL ENERGY, IT IS HIGHLY RECOMMENDED TO POWER OFF EQUIPMENT BEFORE INSPECTING OPTICAL PORTS.**

**IT IS ALSO HIGHLY RECOMMENDED TO USE AN LCD-BASED FIBER INSPECTION SCOPE, WHICH CAN INSPECT OPTICAL PORTS AND FIBER ENDFACES WITHOUT EXPOSING THE EYE TO HARMFUL OPTICAL RADIATION.**

### “WET” CLEAN PROCEDURE

- 1 Wet the tip of a 2.5mm cleaning swab with isopropyl alcohol.
- 2 Carefully insert the wet tip of the swab into the optical port.
- 3 Clean out the optical port according to the directions provided with the swabs.
- 4 Blow dry the optical port with the compressed air. If compressed air is not available, allow 2 minutes for the alcohol to evaporate.
- 5 Inspect the optical port with the in-adapter fiber optic inspection scope to ensure the port is clear of obstructions.

### “DRY” CLEAN PROCEDURE

- 1 Carefully insert a dry 2.5mm cleaning swab or a 2.5mm HUXCleaner™ into the optical port.
  - 2 Clean out the optical port according to the directions that came with the cleaning accessories.
  - 3 Inspect the optical port with the in-adapter fiber optic inspection scope to ensure the port is clear of obstructions.
- If the port is still dirty, another round of cleaning will be necessary. You may also want to use a combination of “wet” and “dry” cleaning to achieve best results.

If the port is still dirty, another round of cleaning will be necessary. You may also want to use a combination of “wet” and “dry” cleaning to achieve best results.

# SECTION 7: APPENDICES

## SPECIFICATIONS

<b>Optical Specifications</b>				
Fiber Type:	Multimode		Singlemode	
Output Wavelength:	850 nm	1300 nm	1310 nm	1550 nm
Dynamic Range (SNR=1) <sup>2</sup> :	23 dB	26 dB	25 dB	23 dB
Distance Range <sup>5</sup> :	12 miles (20 kilometers)		80 miles (128 kilometers)	
Event Dead Zone <sup>3</sup> :	2 meters (typical)			
Attenuation Dead Zone <sup>4</sup> :	7 meters (typical)			
Maximum Data Points:	64000			
Data Point Spacing:	1 meter		Up to 64 km: 1 meter / Over 64 km: 2 meters	
Pulse Width:	1, 2, 5, 10, 20, 50, 100 meters		1, 2, 5, 10, 20, 50, 100, 200, 500, 1000 meters	
Index of Refraction:	1.4000 to 1.6000			
Distance Accuracy:	Up to 64km: 1 + (distance in meters/10000) / Over 64km: 2 + (distance in meters/10000)			
Number of Stored Traces:	Maximum trace distance: up to 200 / Minimum trace distance: 3000+			

1: All price shown are in US Dollars (USD). List price is shown for US customers only. Prices outside the US may vary based on individual countries' import duties and taxes, currency conversion, and other value added charges.

2: Using maximum pulse width

3: Width measured 1.5dB down on each side of a reflective event using 1 meter pulse width

4: Distance from event beginning to within 0.5dB where backscatter resumes using 1 meter pulse width

5: Out to furthest reflective event

<b>General Specifications</b>	
Display Type:	High-resolution Color LCD
Display Size:	2.8" diagonal
Battery Type:	Lithium Polymer
Battery Life:	up to 20 hours normal usage
Dimensions:	2.87" x 4.42" x 1.25"
Weight:	10 ounces (284 g)
<b>Visual Fault Locator Specifications</b>	
Output Wavelength:	650nm
Output Power:	1 mW
Operating Mode:	CW / Flash

## MAINTENANCE INFORMATION

**Repair.** Repair of this unit by unauthorized personnel is prohibited, and will void any warranty associated with the unit.

**Battery Replacement.** The OWLTrek contains an internal Lithium Polymer battery. If the battery requires service, the device must be sent in to OWL. Unauthorized attempts to service the battery will void the product warranty.

**Cleaning.** For accurate readings, the optical connector port on the OWLTrek and the connector on the patch cable should be cleaned prior to attaching them to each other. Minimize dust and dirt buildup by replacing the dust caps after each use.

**Warranty.** The OWLTrek comes standard with a two-year factory warranty, which covers manufacturer defect and workmanship only.

## CONTACT INFORMATION

### Address:

Optical Wavelength Laboratories, Inc.  
N9623 US Hwy 12  
Whitewater, WI 53190

### Internet:

OWL-INC.COM

### Phone:

262-473-0643